

## WELCOME

# CERN Courier – digital edition

Welcome to the digital edition of the May/June 2019 issue of *CERN Courier*.

It is 100 years since Ernest Rutherford published his results proving the existence of the proton. For many decades the proton was considered elementary. But ever since experiments at SLAC and DESY started firing electrons into protons, beginning in the 1960s, deep-inelastic-scattering experiments have revealed a complex internal picture. In this issue we take an expert tour of physicists' evolving understanding of the proton, and find that there is still much to learn about this ubiquitous particle – including the origin of its spin, whether or not it decays and the puzzling value of its radius. Flavour physics is another theme of the issue. LHCb's observation of CP violation in the charm sector represents a milestone result, and the collaboration recently released an update of the ratio  $R_K$  concerning the ratio of certain B-meson decays. From a theoretical perspective, new gauge bosons and leptoquarks are promising potential explanations for the current anomalies reported in the b-quark system, although the picture is far from clear and more data are needed. Meanwhile, researchers are also searching for ultra-rare muon decays that violate lepton-number conservation. Also in this issue: LHCb's discovery of a new pentaquark, DESY's astroparticle ambitions, news on the International Linear Collider, the first image of the centre of a galaxy, and more.

To sign up to the new-issue alert, please visit:

<http://cerncourier.com/cws/sign-up>.

To subscribe to the magazine, please visit:

<http://cerncourier.com/cws/how-to-subscribe>.

EDITOR: MATTHEW CHALMERS, CERN  
DIGITAL EDITION CREATED BY DESIGN STUDIO, IOP PUBLISHING, UK

## PERSPECTIVES ON THE PROTON

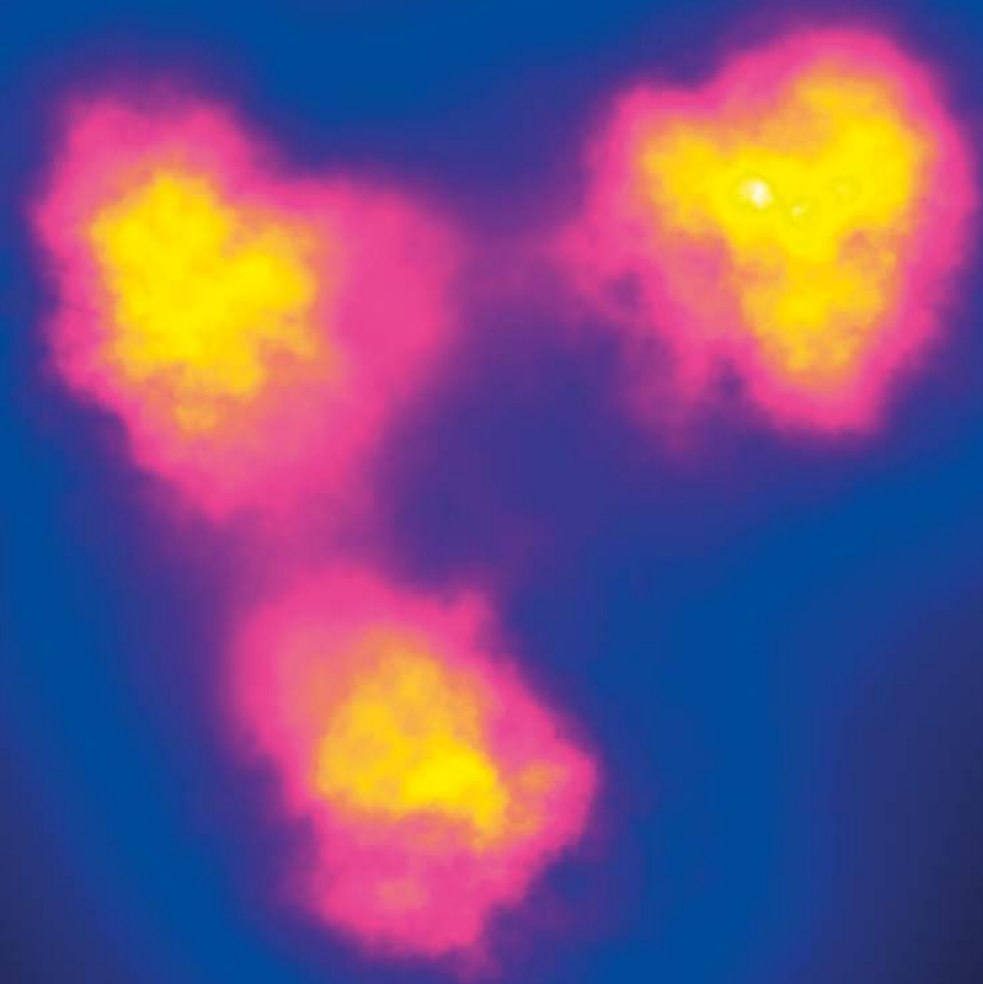

**CP violation in charm decays**  
**SKA and treaty-based science**  
**Reports from Moriond**



## It's Time for a New Generation of Power Solutions!

FOR RESISTIVE AND SUPERCONDUCTING MAGNETS

Digital Output Control Precision Current Measurements  
Bipolar and Unipolar Power Converters  
Fast Connectivity Waveform Generation  
Embedded Linux OS Magnetic Load Protections  
Extreme Stability



**CAENels**  
Gear For Science

FIRST PHYSICS,  
NOW INDUSTRY

**CT-BOX**  
CURRENT TRANSDUCER - 400A

ALL-IN-ONE CURRENT MEASUREMENT AND CALIBRATION SYSTEM

**Easy-Driver**

DIGITAL BIPOLAR POWER SUPPLY AT AN INCREDIBLE PRICE

**FAST-PS-M**

DIGITAL MONOPOLAR FAST POWER SUPPLY SERIES

**FAST-PS**

DIGITAL BIPOLAR FAST POWER SUPPLY SERIES

**FAST-PS-1K5**

1.5 kW DIGITAL BIPOLAR FAST POWER SUPPLY SERIES

**NGPS**

10 kW HIGH STABILITY CURRENT AND VOLTAGE POWER SUPPLY

### CT-BOX

**All-In-One Current Measurement and Calibration System**  
Up to  $\pm 1.000$  A, 1 ppm/K TC, 100 kpsps Data-Logger and Oscilloscope  
CT-Viewer software included with Ethernet, Serial and USB

### EASY-DRIVER

**$\pm 5$  A and  $\pm 10$  A /  $\pm 20$  V Bipolar Power Supply Series**  
Full-Bipolar operation, Digital Control Loop, Ethernet Connectivity  
Device supported by Visual Easy-Driver software

### FAST-PS-M

**Digital Monopolar Power Supplies - up to 100 A**  
High-Precision Monopolar Power Converters with Gigabit Ethernet  
Embedded Linux OS, device supported by Visual PS software

### FAST-PS

**Digital Bipolar Power Supplies - up to  $\pm 30$  A and  $\pm 80$  V**  
Full-Bipolar, Digital Control Loop, High-Bandwidth, 10/100/1000 Ethernet  
Embedded Linux OS, device supported by Visual PS software

### FAST-PS-1K5

**Digital Bipolar Power Supplies - up to  $\pm 100$  A and  $\pm 100$  V**  
1.500 W, Paralleling via SFP/SFP+, 1 ppm/K TC, 10/100/1000 Ethernet  
Embedded Linux OS, device supported by Visual PS software

### NGPS

**High-Stability 10-kW Power Supply - 200 A / 50 V**  
Digital Control Loop, Paralleling via SFP/SFP+, 10/100/1000 Ethernet  
Embedded Linux OS, device supported by Visual PS software

**CAENels**  
Gear For Science

www.caenels.com



**Impressions** Reports from Moriond 2019. 19

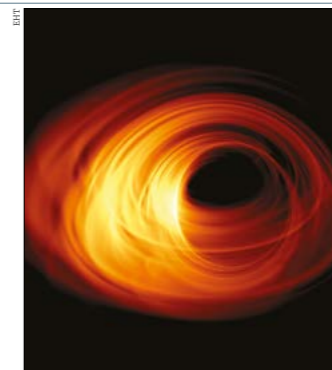

**Black hole** Matching the first image to a model. 10



**MEG II** The elusive muon decay that would signal new physics. 45

## NEWS

### ANALYSIS

LHCb sees CP violation in charm • Japan puts the LLC on ice • SESAME goes solar • Flavour anomalies persist • Wakefield record broken. 7

### ENERGY FRONTIERS

New pentaquarks at LHCb • ALICE on high- $p_T$  suppression • CMS boosts search for fourth-generation quarks • ATLAS squeezes SUSY. 15

### FIELD NOTES

Moriond 2019 • Feynman centenary • FCC and industry • Wakefield accelerators • Vienna Conference on Instrumentation • Neutrino connoisseurs talk stats. 19

## PEOPLE

### CAREERS

**Science communication**  
Giovanni Mazzitelli paints a picture of the changing face of science communication. 59

### OBITUARIES

Michael Atiyah 1929–2019 • Hans-Jürg Gerber 1929–2018 • Bastiaan De Raad 1931–2018. 71

## FEATURES



### PROTON CENTENARY

**Rutherford, transmutation and the proton**

The events leading to Ernest Rutherford's discovery of the proton, published in 1919. 27

### LEPTON-FLAVOUR UNIVERSALITY

#### The flavour of new physics

Recent experimental results hint that some electroweak processes are not lepton-flavour independent. 33

### THE PROTON

#### The proton laid bare

What a proton is depends on how you look at it, or rather on how hard you hit it. Our picture of this ubiquitous particle is coming into focus. 38

### LEPTON-FLAVOUR CONSERVATION

#### Hunting the muon's forbidden decay

MEG II is gearing up to search for the muon's flavour-violating decay to a positron and a photon. 45

## OPINION

### VIEWPOINT

#### Building scientific resilience

New political landscapes make international organisations in science more vital than ever. 49

### INTERVIEW

#### DESY's astroparticle aspirations

Christian Stegmann, describes the ambitious plans for the German laboratory. 51

### REVIEWS

#### Multi-messenger adventures

Introduction to Particle and Astroparticle Physics • Rutherford • Quàntica. 55

## DEPARTMENTS



**On the cover:**  
The fluctuating gluon density of a high-energy proton, after PRL 117 052301 (image by H.Mäntysaari). 5

FROM THE EDITOR	5
NEWS DIGEST	13
APPOINTMENTS & AWARDS	61
RECRUITMENT	63
BACKGROUND	74

# bergoz

INSTRUMENTATION

More than 35 Years of experience  
recognized in the world of particle accelerator



### Turbo-ICT & BCM-RF

Optimized to measure short bunches with very low charge

Resolution down to 10 fC



### CWCT & BCM-CW

Developped to measure the average beam current of CW beams or macropulses

Resolution down to 1 uA

Visit [www.bergoz.com](http://www.bergoz.com)

#### DISTRIBUTORS

**U.S.A.:** GMW Associates  
[www.gmw.com](http://www.gmw.com)  
[sales@gmw.com](mailto:sales@gmw.com)

**Japan:** Hayashi-Repic  
[www.h-repic.co.jp](http://www.h-repic.co.jp)  
[info\\_web@h-repic.co.jp](mailto:info_web@h-repic.co.jp)

**India:** GEEBEE International  
[www.geebinternational.com](http://www.geebinternational.com)  
[info@geebinternational.com](mailto:info@geebinternational.com)

**China:** Beijing Conveyi Limited  
[www.conveyi.com](http://www.conveyi.com)  
[sales@conveyi.com](mailto:sales@conveyi.com)

#### MANUFACTURER

BERGOZ Instrumentation  
[www.bergoz.com](http://www.bergoz.com)  
Espace Allondon Ouest  
01 630 Saint Genis Pouilly, France  
[info@bergoz.com](mailto:info@bergoz.com)

# FROM THE EDITOR

## A peek into the proton's complexity



Matthew Chalmers  
Editor

How do you visualise a proton? A high-school student might sketch a circle containing three blobs connected by springs; an artist might go further by attempting to capture some of the dynamical mayhem of valence quarks, sea quarks and gluons (see right). Ask a phenomenologist, and you could get something like the image on the cover of this issue – a representation, constrained by HERA data, of the fluctuating gluon density around the valence quarks of the proton (or, more precisely, a heat map of the trace of the Wilson line encoding the proton structure at given transverse point). At best, each of these pictures gives a limited view of this ubiquitous particle.

For decades following Rutherford's 1919 discovery (p27), the proton was considered elementary. But ever since experiments at SLAC started firing electrons into protons in the 1960s, revealing the existence of point-like scattering centres, and those at DESY uncovered the gluon in 1979, deep-inelastic-scattering experiments have revealed a complex internal picture. In short, what a proton looks like depends on how hard – and with what – you hit it. In this issue (p38), Amanda Cooper-Sarkar gives an expert tour of our evolving picture of the proton, and argues that a deeper understanding is key to the search for new physics.

Surprisingly, on its centenary, there is still much to learn about the proton: the origin of its spin (p39); whether or not it decays on long timescales (p40); and the puzzling, although soon-to-be resolved, value of its radius, as we report on p41. Meanwhile, ultra-precise experiments comparing protons with antiprotons, discovered in 1955, continue apace at experiments such as BASE at CERN's Antiproton Decelerator. Recently, for a short period, BASE's measurement of the magnetic moment of the antiproton with a relative precision of 1.5 parts per billion represented the first time that antimatter had been measured more precisely than matter. So far, no differences between the proton and the antiproton have been seen. What is beyond doubt, however, is the continuing importance of the proton in allowing physicists to probe nature's smallest constituents

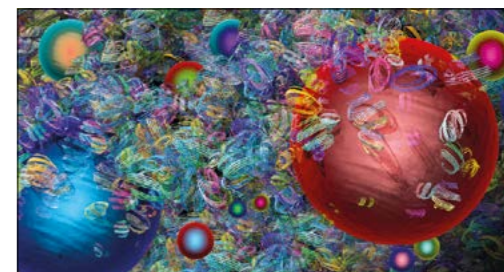

Colourful Artistic depiction of the proton's complexity.

and, increasingly, in driving medical imaging and advanced cancer treatments.

#### Change of flavour

Flavour physics is another theme of this issue, and was a focus of discussions during the electroweak session of the 2019 Rencontres de Moriond (p19). A stand-out new result was LHCb's observation of CP violation in the charm sector (p7), and the collaboration also released an eagerly awaited update of the ratio  $R_b$ , based on Run 2 data which leaves the interesting picture of b-decay anomalies poised at the same statistical significance, despite new data (p9). Updated with the latest results from experiment, our feature by theorists Jure Zupan and Jorge Martin pulls the big picture together (p33). Complementary to these challenges to lepton-flavour universality, the MEG-II collaboration describes an upcoming run to search for an ultra-rare muon decay that violates lepton-number conservation (p45).

Also in this issue, read about LHCb's discovery of a new pentaquark (p15), DESY's plans to expand its astroparticle physics activities (p51), news from Japan on the International Linear Collider (p8), the increasing importance of intergovernmental organisations in science (p49), and the first-ever images of the centre of a galaxy (p10). Enjoy!

#### Flavour physics is another theme of this issue

#### Reporting on international high-energy physics

CERN Courier is distributed to governments, institutes and laboratories affiliated with CERN, and to individual subscribers. It is published six times per year. The views expressed are not necessarily those of the CERN management.

**Editor**  
Matthew Chalmers  
**Associate editor**  
Mark Rayner  
**Archive contributor**  
Peggie Rimmer  
**Astrowatch contributor**  
Merlin Kole  
**E-mail**  
[cern.courier@cern.ch](mailto:cern.courier@cern.ch)

**Advisory board**  
Peter Jenni,  
Christine Sutton,  
Claude Amisler,  
Philippe Bloch,  
Roger Forty,  
Mike Lamont,  
Matthew McCullough

**Laboratory correspondents:**  
**Argonne National Laboratory** Tom LeCompte  
**Brookhaven National Laboratory** Achim Franz  
**Cornell University** D G Cassel  
**DESY Laboratory** Till Mundt  
**Enrico Fermi Centre** Guido Piragino  
**Fermilab** Kurt Riesselmann  
**Forschungszentrum Jülich** Markus Buescher  
**GSI Darmstadt** I Peter  
**IHEP, Beijing** Lijun Guo  
**IHEP, Serpukhov** Yu Ryabov

**INFN Antonella Varaschin**  
**Jefferson Laboratory** Kandice Carter  
**JINR Dubna** B Starchenko  
**KEK National Laboratory** Hajime Hikino  
**Lawrence Berkeley Laboratory** Spencer Klein  
**Los Alamos National Lab** Rajan Gupta  
**NCSL** Ken Kingery  
**Nikhef** Robert Fleischer  
**Novosibirsk Institute** S Eidelman  
**Orsay Laboratory** Anne-Marie Lutz  
**PSI Laboratory P-R** Kettle  
**Saclay Laboratory** Elisabeth Locci  
**UK STFC** Jane Binks

**SLAC National Accelerator Laboratory** Melinda Baker  
**SNOLAB** Samantha Kuula  
**TRIUMF Laboratory** Marcello Pavan

**Produced for CERN by IOP Publishing Ltd**  
Temple Circus, Temple Way, Bristol BS1 6HG, UK  
Tel +44 (0)117 929 7481

**Head of B2B and journalism** Jo Allen  
**B2B commercial operations manager** Ed Jost  
**Art director** Andrew Giaquinto

**Production editor** Ruth Leopold  
**Technical illustrator** Alison Tovey  
**Advertising sales** Tom Houlden  
**Recruitment sales** Chris Thomas  
**Advertisement production** Katie Graham  
**Marketing and circulation** Angela Gage, Laura Gillham

**Advertising**  
Tel +44 (0)117 930 1026  
(for UK/Europe display advertising) or +44 (0)117 930 1164 (for recruitment)

advertising; e-mail [sales@cerncourier.com](mailto:sales@cerncourier.com)

**General distribution**  
Courier Adresse, CERN, 1211 Geneva 23, Switzerland; e-mail [courier-adresse@cern.ch](mailto:courier-adresse@cern.ch)

**Published by** CERN, 1211 Geneva 23, Switzerland  
Tel +41 (0) 22 767 61 11

**Printed by** Warners (Midlands) plc, Bourne, Lincolnshire, UK

© 2019 CERN  
ISSN 0304-288X

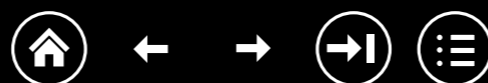

# MicroTCA SYSTEM INTEGRATION

HARDWARE  
SOFTWARE  
SYSTEM

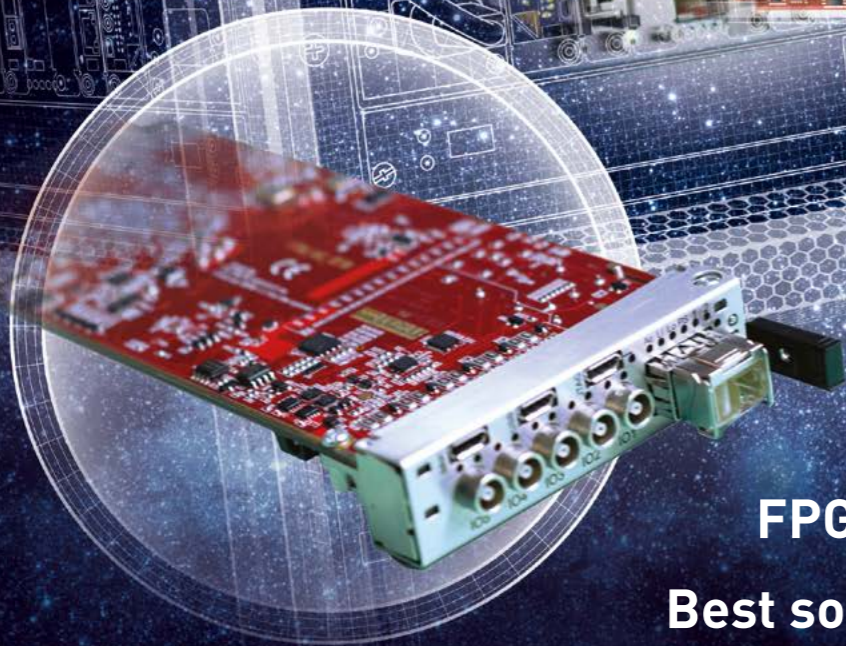

- Schematics
- Prototyping
- High speed DAQ
- FPGA programming
- Best solutions portfolio

Your **TRUSTED** Control System Partner



**COSYLAB**

[www.cosylab.com/mtca](http://www.cosylab.com/mtca)

## NEWS ANALYSIS

CP VIOLATION

### LHCb observes CP violation in charm decays

On the morning of 21 March, at the 2019 Rencontres de Moriond in La Thuile, Italy, the LHCb collaboration announced the discovery of charge-parity (CP) violation in the charm system. Met with an impromptu champagne celebration, the result represents a milestone in particle physics and opens a new area of investigation in the charm sector.

CP violation, which results in differences in the properties of matter and anti-matter, was first observed in the decays of K mesons (which contain strange quarks) in 1964 by James Cronin and Val Fitch. Even though parity (P) violation had been seen eight years earlier, the discovery that the combined C and P symmetries are not conserved was unexpected. The story deepened in the early 1970s, when, building on the foundations laid by Nicola Cabibbo and others, Makoto Kobayashi and Toshihide Maskawa showed that CP violation could be included naturally in the Standard Model (SM) if at least six different quarks existed in nature. Their fundamental idea – whereby direct CP violation arises if a complex phase appears in the CKM matrix describing quark mixing – was confirmed 30 years later by the discovery of CP violation in B-meson decays by the BaBar and Belle collaborations. Despite decades of searches, CP violation in the decays of charmed particles escaped detection.

LHCb physicists used the unprecedented dataset accumulated in 2011–2018 to study the difference in decay rates between  $D^0$  and  $\bar{D}^0$  (which contain a c quark or antiquark) decaying into  $K^+K^-$  or  $\pi^+\pi^-$  pairs. To differentiate between the identical  $D^0$  and  $\bar{D}^0$  decays, the collaboration exploited two different classes of decays: those of  $D^{*+}$  mesons decaying into a  $D^0$  and a charged pion, where the presence of a  $\pi^-(\pi^+)$  indicates the presence of a  $D^0(\bar{D}^0)$  meson; and those of B mesons decaying into a  $D^0$ , a muon and a neutrino, in which the presence of a  $\mu^-(\mu^+)$  identifies a  $D^0(\bar{D}^0)$ . Counting the number of decays present in the data sample, the final result is  $\Delta A_{CP} = -0.154 \pm 0.029\%$ . At 5.3 standard deviations from zero, it represents the first observation of CP violation in the charm system.



Experimental highlight The LHCb detector in December being prepared for upgrades.



Champagne moment Members of the LHCb collaboration who were present at the announcement.

“This is a major result that could be obtained thanks to the very high charm-production cross section at LHC, and to the superb performance of both the LHC machine and the LHCb detector, which provided the largest sample of charm particles ever collected,” says LHCb spokesperson Giovanni Passaleva. “Analysing the tens of millions of  $D^0$  mesons needed for such a precise measurement was a remarkable collective effort by the collaboration. The result opens up a new field in particle physics, involving the study of CP-violating effects in the sector of up-type quarks and searches for new-physics effects in a completely new domain.”

CP violation is a thought to be an essential ingredient to explain the observed cosmological matter-anti-matter asymmetry, but the level of CP

violation observed in the SM is only able to explain a fraction of the imbalance. In addition to hunting for novel sources of CP violation, physicists are making precise measurements of known sources to look for deviations that could indicate physics beyond the SM. The SM prediction for the amount of CP violation in charm decays is estimated to be in the range of  $10^{-4} - 10^{-3}$  in the decay modes of interest. The new LHCb measurement is consistent with the SM expectation but falls at the upper end of the range, generating much discussion at Moriond 2019. Unusually for particle physics, the experimental measurement is much more precise than the SM prediction. This is due to the lightness of charm quarks, which means that reliable perturbative QCD and other approximate calculation techniques are not possible. Future theoretical improvements, and data, will establish whether the seminal LHCb result is consistent with the SM.

“This is an important milestone in the study of CP violation,” Kobayashi, now professor emeritus at KEK in Japan, tells *CERN Courier*. “I hope that analysis of the results will provide a clue to new physics.”

**Further reading**

LHCb Collaboration 2019 arXiv:1903.08726 (submitted to *Phys. Rev. Lett.*).

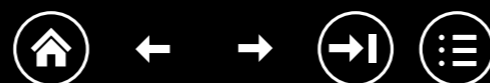

## FACILITIES

## Physicists digest Japan's ILC statement

The Japanese government has put on hold a decision about hosting the International Linear Collider (ILC), to the disappointment of many hoping for clarity ahead of the update of the European strategy for particle physics. At a meeting in Tokyo on 6–7 March, Japan's Ministry of Education, Culture, Sports, Science and Technology (MEXT) announced, with input from the Science Council of Japan (SCJ), that it has "not yet reached declaration" for hosting the ILC at this time. A statement from MEXT continued: "The ILC project requires further discussion in formal academic decision-making processes such as the SCJ Master Plan, where it has to be clarified whether the ILC project can gain understanding and support from the domestic academic community... MEXT will continue to discuss the ILC project with other governments while having an interest in the ILC project."

The keenly awaited announcement was made during the 83rd meeting of the International Committee for Future Accelerators (ICFA) at the University of Tokyo. During a press briefing, ICFA chair Geoffrey Taylor emphasised that colliders are long-term projects. "At the last strategy update in 2013 the ILC was seen as an important development in the field, and we were hoping there would be a definite statement from Japan so that it can be incorporated into the current strategy update," he said. "We don't have that positive endorsement, so it will proceed at a slower rate than we hoped. ICFA still supports Japan as hosts of the ILC, and we hope it is built here because Japan has been working hard towards it. If not, we can be sure that there will be somewhere

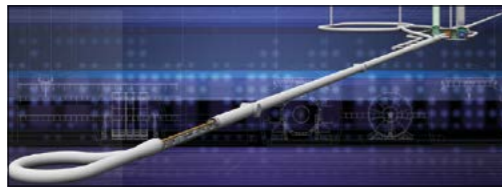

**Machine in limbo**  
The ILC would collide electrons and positrons at an energy of 250 GeV, with the possibility of energy upgrades.

else in the world where the project can be taken up."

The story of the ILC, an electron-positron collider that would serve as a Higgs factory, goes back more than 15 years. In 2012, physicists in Japan submitted a petition to the Japanese government to host the project. A technical design report was published the following year. In 2017, the original ILC design was revised to reduce its centre-of-mass energy by half, shortening it by around a third and reducing its cost by up to 40% (CERN Courier January/February 2018 p7).

Meanwhile, MEXT has been weighing up the ILC project in terms of its scientific significance, technical challenges, cost and other factors. In December 2018, the SCJ submitted a critical report to MEXT highlighting perceived issues with the project, including its cost and international organisation. Asked at the March press briefing why the SCJ should now be expected to change its views on the ILC, KEK director-general Masanori Yamauchi responded: "We can show that we already have solutions for the technical challenges pointed out in the latest SCJ report, and we are going to start making a framework for international cost-sharing."

Writing in LC NewsLine, Lyn Evans, director of the Linear Collider Collabora-

tion (which coordinates planning and research for the ILC and CERN's Compact Linear Collider, CLIC), remains upbeat: "We did not get the green light we hoped for. Nevertheless, there was a significant step forward with a strong political statement and, for the first time, a declaration of interest in further discussions by a senior member of the executive. We will continue to push hard."

Japan's statement has also been widely interpreted as a polite way for the government to say "no" to the ILC. "The reality is that it is naturally difficult for people outside the machinery of any national administration to understand fully how procedures operate, and this is certainly true of the rest of the world with regard to what is truly happening with ILC in Japan," says Phil Burrows of the University of Oxford, who is spokesperson for the CLIC accelerator collaboration. A full spectrum of views was expressed at a meeting of the linear-collider community in Lausanne, Switzerland, on 8–9 April, with around 100 people present. "The global community represented at the Lausanne meeting restated the overwhelming physics case for an electron-positron collider to make precision measurements in the Higgs and top-quark sectors, with superb sensitivity to new physics," says Burrows. "We are in the remarkable situation that we have not one, but two, mature options for doing this: ILC and CLIC. I hope that the European Strategy Update recommendations will reflect this consensus on the physics case, position Europe to play a leading role, and hence ensure that one of these projects proceeds to realisation."

**A full spectrum of views was expressed at a meeting in Lausanne**

## LIGHT SOURCES

## SESAME synchrotron goes all-solar

On 26 February, a new solar power plant powering the SESAME light source in Jordan was officially inaugurated. In addition to being the first synchrotron-light facility in the Middle East region, SESAME is now the world's first major research infrastructure to be fully powered by renewable energy.

Electricity from the solar power plant will be supplied by an on-grid photovoltaic system constructed 30km away, and its 6.48 MW power capacity is ample to satisfy SESAME's needs for several years.

"As in the case of all accelerators, SESAME is in dire need of energy, and as the number of its users increases so will its electricity bill," says SESAME director Khaled Toukan. "Given the very high cost of electricity in Jordan, with this solar power plant the centre becomes sustainable."

Energy efficiency and other environmental factors are coming under growing scrutiny at large research infrastructures worldwide. The necessary funding for the SESAME installation became available in late 2016 when the Government of Jordan agreed to allocate JD 5 million (US\$7.05 million) from funds provided by the European Union (EU) to support the deployment of clean energy sources. The power plant, which uses monocrystalline



**Energy efficient**  
The new solar farm powering SESAME.

solar panels, was built by the Jordanian company Kawar Energy and power that is transmitted to the grid will be accounted for to the credit of SESAME.

SESAME opened its beamlines to users in July 2018. Cyprus, Egypt, Iran, Israel, Jordan, Pakistan, Palestine and Turkey are currently members of SESAME, with 16 further countries – plus CERN and the EU – listed as observers.

## LEPTON FLAVOUR UNIVERSALITY

## Flavour anomalies continue to intrigue

The LHCb collaboration has released a much anticipated update on its measurement of  $R_K$  – a ratio that describes how often a  $B^+$  meson decays to a charged kaon and either a  $\mu^+\mu^-$  or an  $e^+e^-$  pair, and therefore provides a powerful test of lepton universality. The more precise measurement, officially revealed at Rencontres de Moriond on 22 March, suggests that the intriguing current picture of flavour anomalies persists.

Since 2013, several results involving the decay of b quarks have hinted at deviations from lepton universality, a tenet of the Standard Model (SM), though none is individually significant enough to constitute evidence of new physics. LHCb has studied a number of ratios comparing b decays to different leptons and also sees signs that something is amiss in angular distributions of  $B \rightarrow K^* \mu^+ \mu^-$  decays. Data from BaBar and Belle add further intrigue, though with lower statistical significances.

The latest measurement from LHCb is the first lepton-universality test performed using part of the 13 TeV Run 2 data set (2015–2016) together with the full Run 1 data sample, representing in total an integrated luminosity of  $5\text{fb}^{-1}$ . The blinded analysis was performed in the range  $1.1 < q^2 < 6.0 \text{ GeV}^2$ , where  $q^2$  is the invariant mass of the  $\mu^+\mu^-$  or  $e^+e^-$  pair. It

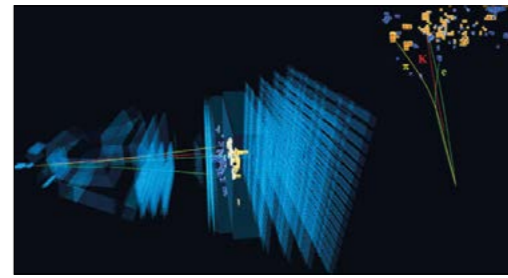

## Deviations

The decay of a  $B^+$  meson into a  $K^0$  and an  $e^+e^-$  pair, used to test lepton universality in the Standard Model, recorded by LHCb.

found  $R_K = 0.846^{+0.050}_{-0.054}(\text{stat})^{+0.016}_{-0.014}(\text{syst})$ , the most precise measurement to date. However, having shifted closer to the Standard Model prediction, the value leaves the overall significance unchanged at about 2.5 standard deviations.

"I cannot tell you if lepton-flavour universality is broken or not, so sorry for this!" said Thibaud Humair of Imperial College London, who presented the result on behalf of the LHCb collaboration. "All LHCb results for  $R_K$  are below SM expectations. Together with  $b \rightarrow s \mu^+ \mu^-$  results,  $R_K$  and  $R_{K^*}$  constitute an interesting pattern of anomalies, but the significance is still low," he said.

Humair's talk generated much discussion, with physicists pressing LHCb on potential sources of uncertainties and other possible explanations such as the

dependence of  $R_K$  on  $q^2$ . Other experiments also showed new measurements of lepton universality and other related tests of the Standard Model, such as ATLAS on the branching ratio of  $B_c \rightarrow \mu^+ \mu^-$  and an update from Belle on both  $R_{D^{(*)}}$  and  $R_{K^*}$ . The current experimental activity in flavour physics was reflected by several talks at Moriond from theorists.

"It's not a discovery, but something is going on," says David Straub of TUM Munich, who had spent the previous 24 hours working solid to update a global likelihood fit of all parameters relevant to the b anomalies with the updated LHCb and Belle results. The fit, which involves 265 observables showed that  $b \rightarrow s l^+ l^-$  observables such as  $R_K$  continue to show a "large pull" towards new-physics. "The popular 'U1 leptoquark' is still giving excellent fit to the data", says Straub.

Further reduction in the uncertainty on  $R_K$  can be expected when the data collected by LHCb in 2017 and 2018 are included in a future analysis. Meanwhile, in Japan, the Belle II physics programme has now begun in earnest and the collaboration is expected to bring further statistical power to the b-anomaly question in the near future.

## Further reading

LHCb Collaboration 2019 arXiv:1903.09252.

## ACCELERATORS

## BELLA sets new record for plasma acceleration

A world record for laser-driven wakefield acceleration has been set by a team at the Berkeley Lab Laser Accelerator (BELLA) Center in the US. Physicists used a novel scheme to channel 850 TW laser pulses through a 20 cm-long plasma, allowing electron beams to be accelerated to an energy of 7.8 GeV – almost double the previous record set by the same group in 2014.

Proposed 40 years ago, plasma-wakefield acceleration can produce gradients hundreds of times higher than those achievable with conventional techniques based on radio-frequency cavities. It is often likened to surfing a wave. Relativistic laser pulses with a duration of the order of the plasma period generate large-amplitude electron plasma waves that displace electrons with respect to the background ions, allowing the plasma

waves to accelerate charged particles to relativistic energies. Initial work showed that TeV energies could be reached in just a few hundred metres using multiple laser-plasma accelerator stages, each driven by petawatt laser pulses propagating through a plasma with a density of about  $10^{17} \text{ cm}^{-3}$ . However, this requires the focused laser pulses to be guided over distances of tens of centimetres. While a capillary discharge is commonly used to create the necessary plasma channel, achieving a sufficiently deep channel at a plasma density of  $10^{17} \text{ cm}^{-3}$  is challenging.

In the latest BELLA demonstration, the plasma channel produced by the capillary discharge was modified by a nanosecond-long "heater" pulse that confined the focused laser pulses over the 20 cm distance. This allowed for the accel-

**Light work** The plasma channel's electron density profile (blue) formed inside a sapphire tube (grey) with the combination of an electrical discharge and ultrashort laser pulse (red, orange, and yellow).

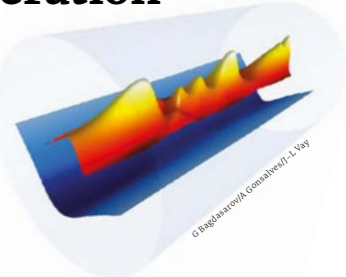

eration of electron beams with quasi-monoenergetic peaks up to 7.8 GeV. "This experiment demonstrates that lasers can be used to accelerate electrons to energies relevant to X-ray free-electron lasers, positron generation, and high-energy collider stages," says lead author Tony Gonsalves. "However, the beam quality currently available from laser-wakefield accelerators is far from that required by future colliders." ▸



The quality of the accelerated electron beam is determined by how background plasma electrons are trapped in the accelerating and focusing “bucket” of the plasma wave. Several different methods of initiating electron trapping have been proposed to improve the beam emittance and brightness significantly beyond state-of-the-art particle sources, representing an important area of research. Another challenge, says Gonsalves, is to improve the stability and reproducibility of the accelerated electron beams, which are currently limited by fluctuations in the laser systems caused by air and ground motion.

### The field of plasma wakefield acceleration is picking up speed

In addition to laser-driven schemes, particle-driven plasma acceleration holds promise for high-energy physics applications. Experiments using electron-beam drivers are ongoing and planned at various facilities including FLASHForward at DESY and FACET-II at SLAC (*CERN Courier* January/February 2019 p10). The need for staging multiple plasma accelerators may even be circumvented by using energetic proton beams as drivers. Recent experiments at CERN’s Advanced Wakefield Experiment demonstrated electron acceleration gradients of around 200 MV/m using proton-beam-driven plasma wakefields (*CERN Courier*

October 2018 p7).

Experiments at Berkeley in the next few years will focus on demonstrating the staging of laser-plasma accelerators with multi-GeV energy gains. “The field of plasma wakefield acceleration is picking up speed,” writes Florian Grüner of the University of Hamburg in an accompanying *APS Viewpoint* article. “If plasma wakefields can have gradients of 1 TV/m, one might imagine that a ‘table-top version of CERN’ is possible.”

#### Further reading

A Gonsalves *et al.* 2019 *Phys. Rev. Lett.* **122** 084801.

### ASTROWATCH: SUPERMASSIVE BLACK HOLES

## First images of the centre of a galaxy

On 10 April, researchers working on the Event Horizon Telescope – a network of eight radio dishes that creates an Earth-sized interferometer – released the first direct image of a black hole. The landmark result, which shows the radiation emitted by superheated gas orbiting the event horizon of a super massive black hole in a nearby galaxy, opens a brand new window on these incredible objects.

Super massive black holes (SMBHs) are thought to occupy the centre of most galaxies, including our own, with masses up to billions of solar masses and sizes up to 10 times larger than our solar system. Discovered in the 1960s via radio and optical measurements, their origin, as well as their nature and surrounding environments, remain important open issues within astrophysics. Spatially resolved images of an SMBH and the potential accretion disks around them form vital input, but producing such images is extremely challenging.

SMBHs are relatively bright in radio wavelengths. However, since the imaging resolution achievable with a telescope scales with the wavelength (which is long in the radio range) and scales inversely with the telescope diameter, it is difficult to obtain useful images in the radio region. For example, producing an image with the same resolution as the optical Hubble Space Telescope would require a km-wide telescope, while obtaining a resolution that would allow an SMBH to be imaged, would require a telescope diameter of thousands of kilometres. One way around this is to use interferometry to turn many telescopes dishes at different locations into one large telescope. Such an interferometer measures the differences in arrival time of one radio wave at

different locations on Earth (induced by the difference in travel path), from which it is possible to reconstruct an image on the sky. This does not only require a large coordination between many telescopes around the world, but also very precise timing, vast amounts of collected data and enormous computing power.

Despite the considerable difficulties, the Event Horizon Telescope project used this technique to produce the first image of an SMBH using an observation time of only tens of minutes. The imaged SMBH lies at the centre of the supergiant elliptical galaxy Messier 87, which is located in the Virgo constellation at a distance of around 50 million light years. Although relatively close in astronomical terms, its very large mass makes its size on the sky comparable to that of the much lighter SMBH in the centre of our galaxy. Furthermore, its accretion rate (brightness) is variable on longer time scales, making it easier to image. The resulting image (above) shows the clear shadow of the black hole in the centre surrounded by an asymmetric ring caused by radio waves that are bent around the SMBH by its strong gravitational field. The asymmetry is likely a result of relativistic beaming of part of the disk of matter which moves towards Earth.

The team compared the image to a range of detailed simulations in which parameters such as the black hole’s mass, spin and orientation were varied. Additionally, the characteristics of the matter around the SMBH, mainly hot electrons and ions, as well as the magnetic field properties were varied. While the image alone does not allow researchers to constrain many of these parameters, combining it with X-ray data taken by the Chandra and NuSTAR telescopes enables



#### Dark secrets

The black hole’s event horizon is around 2.5 times smaller than the shadow (orange) it casts and measures just under 40 billion kilometres across – large enough to contain the entire solar system.

a deeper understanding. For example, the combined data constrain the SMBH mass to 6.5 billion solar masses and appears to exclude a non-spinning black hole. Whether the matter orbiting the SMBH rotates in the same direction or opposite to the black hole, as well as details on the environment around it, will require additional studies. Such studies can also potentially exclude alternative interpretations of this object; currently, exotic objects like boson stars, gravastars and wormholes cannot be fully excluded.

The work of the Event Horizon Telescope collaboration, which involves more than 200 researchers worldwide, was published in six consecutive papers in *The Astrophysical Journal Letters*. While more images at shorter wavelengths are foreseen in the future, the collaboration also points out that much can be learned by combining the data with that from other wavelengths, such as gamma-rays. Despite this first image being groundbreaking, it is likely only the start of a revolution in our understanding of black holes and, with it, the universe.

#### Further reading

Event Horizon Telescope Collaboration 2019 *ApJL* **875** L1–L6.

### CERN

## Welcome to the Science Gateway

On 8 April, CERN unveiled plans for a major new facility for scientific education and outreach. Aimed at audiences of all ages, the Science Gateway will include exhibition spaces, hands-on scientific experiments for schoolchildren and students, and a large amphitheatre to host science events for experts and non-experts alike. It is intended to satisfy the curiosity of hundreds of thousands of visitors every year and is core to CERN’s mission to educate and engage the public in science.

“We will be able to share with everybody the fascination of exploring and learning how matter and the universe work, the advanced technologies we need to develop in order to build our ambitious instruments and their impact on society, and how science can influence our daily life,” says CERN director-general, Fabiola Gianotti. “I am deeply grateful to the donors for their crucial support in the fulfilment of this beautiful project.”

The overall cost of the Science Gateway, estimated at 79 m Swiss Francs, is entirely funded through donations. Almost three quarters of the cost has already been secured, thanks in particular to a contribution of 45 m Swiss Francs from Fiat Chrysler Automobiles. Other donors include a private foundation in Geneva and *Loterie Romande*, which distributes its profits to public utility projects. CERN is looking for additional donations to cover the full cost of the project.

### CERN

## Serbia becomes CERN Member State

Serbia became the 23rd Member State of CERN, on 24 March, following receipt of formal notification from UNESCO. Ever since the early days of CERN (former Yugoslavia was one of the 12 founding Member States of CERN in 1954, until its departure in 1961), the Serbian scientific community has made strong contributions to CERN’s projects. This includes at the Synchrocyclotron, Proton Synchrotron and Super Proton Synchrotron facilities. In the 1980s and 1990s, physicists from Serbia worked on the DELPHI experiment at CERN’s LEP collider. In 2001, CERN and Serbia concluded an International Cooperation Agreement, leading to Serbia’s participation in the



Connecting An impression of the Science Gateway looking down Route de Meyrin towards Geneva (top) and a scale model of the facility (below).

The Science Gateway will be hosted in iconic buildings with a 7000 m<sup>2</sup> footprint, linking CERN’s Meyrin site and the Globe of Science and Innovation. It is being designed by renowned architects Renzo Piano Building Workshop and intends to “celebrate the inventiveness and creativity that characterise the world of research and engineering”. Construction is planned to start in 2020 and be completed in 2022.

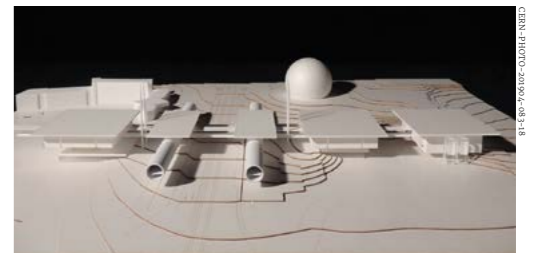

Expanding family Ana Brnabić, Prime Minister of the Republic of Serbia, talking with CERN director-general Fabiola Gianotti during a visit of the Serbian delegation to CERN in September 2018.

ATLAS and CMS experiments at the LHC, in the Worldwide LHC Computing Grid, as well as in the ACE and NA61 experiments. Serbia’s main involvement with CERN today is in the ATLAS and CMS experiments, in the ISOLDE facility, and on design studies for future par-

This will bring new possibilities for our scientists

ticle colliders – FCC and CLIC – both of which are potentially new flagship projects at CERN.

Serbia was an Associate Member in the pre-stage to membership from March 2012. As a Member State, Serbia will have voting rights in the CERN Council, while the new status will also enhance the recruitment opportunities for Serbian nationals at CERN and for Serbian industry to bid for CERN contracts. “Investing in scientific research is important for the development of our economy and CERN is one of the most important scientific institutions today,” says Ana Brnabić, Prime Minister of Serbia. “I am immensely proud that Serbia has become a fully-fledged CERN Member State. This will bring new possibilities for our scientists and industry to work in cooperation with CERN and fellow CERN Member States.”



# pco.

# intensified sCMOS

the new intensified  
pco.dicam C1 with 16 bit dynamic range



exposure time 4 ns  
with 25 mm intensifier

104 fps  
@ full resolution

enhanced  
extinction ratio gating

intensified sCMOS technology  
2048 x 2048 pixel

with  
CAMERA  
LinkHS  
interface

pco.de

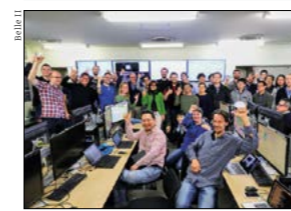

Celebrating first collisions with the full Belle II detector.

#### Data taking begins at Belle II

The fully instrumented Belle II detector recorded its first collisions on 25 March. Belle II will observe events at SuperKEKB, a new asymmetric electron-positron collider in Tsukuba, Japan, which plans to achieve a 40-fold increase on the luminosity of its predecessor, KEKB, which ran from 1999 to 2010. To cope with the increased intensity, Belle has been upgraded with a silicon vertex detector that consists of a two-layer pixel detector and a four-layer double-sided silicon-strip detector. It will observe large quantities of B-meson pairs, allowing a broad range of high-precision measurements in flavour physics.

#### P2O targets Mediterranean Sea

Almost 100 authors from institutes in Europe, Australia and Morocco have submitted a letter of intent to send a neutrino beam 2595 km from the Protvino accelerator facility near Moscow to the KM3NeT/ORCA detector, which is under construction in the Mediterranean Sea, 40 km from the coast of Toulon, France (arXiv 1902.06083). The unusually long baseline of the "P2O" proposal would allow an unparalleled sensitivity to matter effects in the Earth: such matter effects distinguish electron-type neutrinos and antineutrinos via charged current interactions with atomic electrons, allowing for the determination of the neutrino mass hierarchy after a few years of operations. However, say the authors, a significant densification of the ORCA detector would be required to make a competitive measurement of leptonic CP violation.

#### FASER approved for LHC

On 5 March, CERN approved FASER, the Forward Search Experiment, which will look for light and weakly interacting long-lived particles produced parallel to the LHC beam at solid angles that cannot be instrumented by conventional collider detectors. Located 480 m along a tangent from the ATLAS detector, in an unused service tunnel, the core detector will be a 5.5-m-long cylinder with a diameter of only 20 cm, as the sought-after new particles (such as dark photons) would remain tightly collimated after being produced at the interaction point. FASER will use spare parts donated by the ATLAS and LHCb experiments and is supported by the Heising-Simons and Simons foundations. Working to an ambitious schedule, the experiment will begin operating in 2021 after the end of the second long shutdown of the LHC.

#### First light for DESI

On 1 April, the Dark Energy Spectroscopic Instrument (DESI) at the Kitt Peak National Laboratory near Tucson, Arizona, demonstrated the precise focusing and alignment of its lens assembly – a notable achievement as the entire moving mass of the Mayall telescope which houses DESI is 375 tons, and the telescope must target objects with 5 μm accuracy. Having first trained its gaze on the Whirlpool Galaxy (pictured), DESI will eventually collect 360 to 980 nm spectrographs rather than large images, thereby probing redshifts up to 1.7 for emission-line galaxies and up to 3.5 for Lyman-α spectra of quasars. DESI's focal plane will be installed later this year, paving the way for five years of measurements that, in addition to precise measure-

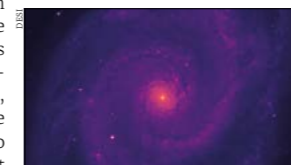

DESI captures the Whirlpool Galaxy.

ments of the expansion history of the universe, may allow the first direct detection of the sum of the neutrino masses at 3σ significance.

#### Squeezing rare kaon decays

The KOTO experiment at Japan's J-PARC laboratory in Tokai has published a 90% confidence limit of  $3.0 \times 10^{-9}$  on the branching ratio for the rare neutral kaon decay  $K_L \rightarrow \pi^0 \nu \bar{\nu}$ , beating the previous world best by an order of magnitude (PRL 122 021802). The experiment, whose name derives from "K<sup>0</sup> at Tokai", uses collisions of 30 GeV protons with a gold target; secondary kaons then travel 20 m before their decays are observed in a 6 m-long vacuum vessel. The main background – hadron clusters induced by the contamination of neutrons in the beam – was eliminated by cuts on the vertex position and the transverse momentum of the neutral pion, and the collaboration is now analysing the larger 2016–2018 dataset. Meanwhile, NA62 at CERN is working on a comparable measurement of the rare charged kaon decay  $K^+ \rightarrow \pi^+ \nu \bar{\nu}$ , to extract a 10% measurement of the CKM parameter  $|V_{td}|$ .

#### No dark photons in NA62

The NA62 experiment at CERN has set the tightest limit to date on the existence of dark photons in the mass range 60 to 110 MeV, using just 1% of its expected dataset (arXiv 1903.08767). Hypothetical dark-sector physics could have an equally rich structure as the Standard Model, and the dark-photon vector field is one possible extension that could mix with the photon in an analogous way to neutrino oscillations. NA62, an experiment primarily geared to searching for rare kaon decays, has employed a different technique to most searches by making use of its supply of neutral pions from kaon decays. The pions decay to two photons, one of which could almost immediately "oscillate" into a dark photon and decay to invisible dark-sector particles. Meanwhile, neighbouring experiment NA64 is expected to also weigh in on the

subject later this month, when results of its search for missing energy in bremsstrahlung radiation will be released.

#### Ground breaking at PIP-II

On 15 March, international partners from France, India, Italy and the UK joined US dignitaries to break ground for a new 215 m-long linear accelerator at Fermilab. Part of the laboratory's Proton Improvement Plan II (PIP-II), this will be the first US accelerator assembled from internationally built components and the new first stage of the accelerator chain that will send a neutrino beam 1300 km to the liquid-argon based DUNE detector in Lead, South Dakota. DOE Under Secretary for Science Paul Dabbar says, "I'm excited for the further cooperation between America's premier particle physics and accelerator laboratory and its international partners, and the resulting better understanding of the universe".



A uniquely international US accelerator.

#### Unnatural cross-fertilisation

Complex-system-modelling expert Sauro Succi of the Italian Institute of Technology, Rome, and Harvard, has answered CERN theory chief Gian Giudice's call for interdisciplinarity in understanding the current challenges to the principle of naturalness in high-energy physics (HEP). Succi's "modest tentative" (Eur. Phys. J. Plus 2019 134 97) explores two areas of physics which exhibit the hallmarks of unnaturalness: fluid turbulence and the ground state of quantum many-body fermions. According to Succi, these are likely to offer "stimulating opportunities for cross-fertilisation between HEP and the physics of complex systems".

# Excellence in precision solutions for particle accelerators



Visit us at IPAC19 in Melbourne Booth G18

Whether your challenges lie in

- Elementary particle research
- Particle therapy applications
- Material characterization

or in providing service in fields such as

- High-energy particle acceleration
- Precise beam forming and monitoring
- Reliable and safe particle storage

With our expertise in high energy RF signal generation, signal amplification and state-of-the-art test and measurement solutions, Rohde & Schwarz is your ideal long term partner.

[www.rohde-schwarz.com/particle-accelerators](http://www.rohde-schwarz.com/particle-accelerators)



R&S®THx9 Amplifier



R&S®RTO digital oscilloscope



R&S®FSWP Phase noise analyzer and VCO tester

# ENERGY FRONTIERS

Reports from the Large Hadron Collider experiments

LHCb

## New pentaquarks resolved by LHCb

The LHCb collaboration has discovered a new pentaquark particle, dubbed the  $P_c(4312)^+$ , decaying to a  $J/\psi$  and a proton, with a statistical significance of 7.3 standard deviations. The LHCb data, first presented at Rencontres de Moriond in March, also confirm that the  $P_c(4450)^+$  structure previously reported by the collaboration in 2015 has now been resolved into two narrow, overlapping peaks, the  $P_c(4440)^+$  and  $P_c(4457)^+$ , with a statistical significance of 5.4 standard deviations compared to the single-peak hypothesis (figure 1). Together, the results offer rich studies of the strong internal dynamics of exotic hadrons.

In the famous 1964 papers that set out the quark model, Murray Gell-Mann and George Zweig mentioned the possibility of adding a quark-antiquark pair to the minimal meson and baryon states  $q\bar{q}$  and  $qqq$ , thereby proposing the new configurations  $qq\bar{q}q$  and  $qqqq\bar{q}$ . Nearly four decades later, the Belle collaboration discovered the surprisingly narrow  $X(3872)$  state with a mass very close to the  $D^0\bar{D}^{*0}$  threshold, hinting at a tetraquark structure ( $c\bar{c}u\bar{u}$ ). A decade after that, Belle discovered narrow  $Z_c^0$  states just above the  $B\bar{B}^*$  and  $B^*\bar{B}^*$  thresholds; this was followed by observations of  $Z_c^0$  states just above the equivalent charm thresholds by BES-III and Belle. The existence of charged  $Z_c^+$  and  $Z_c^0$  partners makes the exotic nature of these states clear: they cannot be described as charmonium ( $c\bar{c}$ ) or bottomonium ( $b\bar{b}$ ) mesons, which are always neutral, but

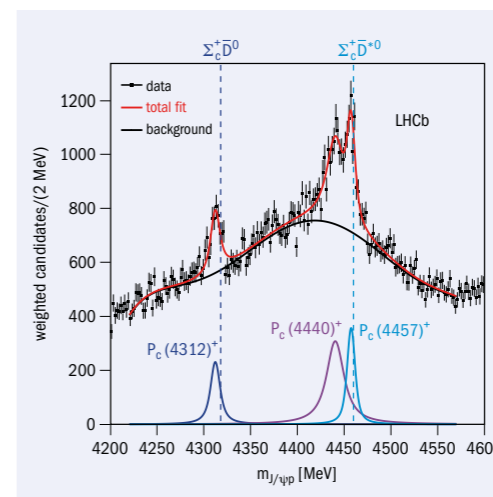

**Fig. 1.** The LHCb collaboration has discovered a new pentaquark, and resolved a previously discovered peak into two. The  $\Lambda_b^0 \rightarrow J/\psi p K^-$  data sample was fitted with three narrow resonances (blue, purple and cyan) plus a polynomial background.

must instead be a combination such as  $c\bar{c}u\bar{d}$ . There is also evidence for broad  $Z_c^+$  states from Belle and LHCb, such as the  $Z_c(4430)^+$ .

A major turning point in exotic baryon spectroscopy was achieved by LHCb in July 2015 when, based on an analysis of Run 1 data, the collaboration reported significant pentaquark structures in the  $J/\psi$ - $p$  mass distribution in  $\Lambda_b^0 \rightarrow J/\psi p K^-$  decays. A narrow  $P_c(4450)^+$  and a

broad  $P_c(4380)^+$  were reported, both with minimal quark content of  $c\bar{c}uud$  (CERN Courier September 2015 p5).

The new results use the data collected at LHCb in Run 1 and Run 2, providing a  $\Lambda_b^0$  sample nine times larger than that used in the 2015 paper. The new data reproduce the parameters of the  $P_c(4450)^+$  and  $P_c(4380)^+$  states when analysed the same way as before. However, the much larger dataset makes a more fine-grained analysis possible, revealing additional peaking structures in the  $J/\psi$ - $p$  invariant mass spectrum that were not visible before. A new narrow peak, with a width comparable to the mass resolution, is observed near 4312 MeV, right below the  $\Sigma_c^+ D^0$  threshold. The structure seen before at 4450 MeV has been resolved into two narrower peaks, at 4440 and 4457 MeV. The latter is right at the  $\Sigma_c^+ D^{*0}$  threshold.

These  $P_c$  states join a growing family of narrow exotic hadrons with masses near hadron-hadron thresholds. This is expected in certain models of loosely bound “molecular” states whose structure resembles the way a proton and neutron bind to form a deuteron. Other models, such as of tightly bound pentaquarks, could also explain the  $P_c$  resonances. A more complete understanding will require further experimental and theoretical investigation.

### Further reading

LHCb Collaboration 2019 arXiv 1904.03947 (submitted to *Phys. Rev. Lett.*).

ALICE

## ALICE sheds new light on high- $p_T$ suppression

The study of lead-ion collisions at the LHC is a window into the quark-gluon plasma (QGP), a hot and dense phase of deconfined quarks and gluons. An important effect in heavy-ion collisions is jet quenching – the suppression of particle production at large transverse momenta ( $p_T$ ) due to energy loss in the QGP. This suppression is quantified by

the nuclear-modification factor  $R_{AA}$ , which is the ratio of particle production rate in Pb-Pb collisions to that in proton-proton collisions, scaled for the number of binary nucleon-nucleon collisions. A measured nuclear modification factor of unity would indicate the absence of final-state effects such as jet quenching.

**The data show a dramatically different behaviour in peripheral Pb-Pb collisions**

Previous measurements of peripheral collisions revealed less suppression than seen in head-on collisions, but  $R_{AA}$  remained significantly below unity. This observation indicates the formation of a dense and strongly interacting system – but it also poses a puzzle. In p-Pb collisions, no suppression has been observed, even though the  $\Delta$

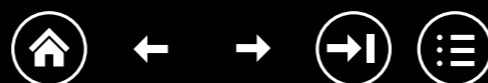



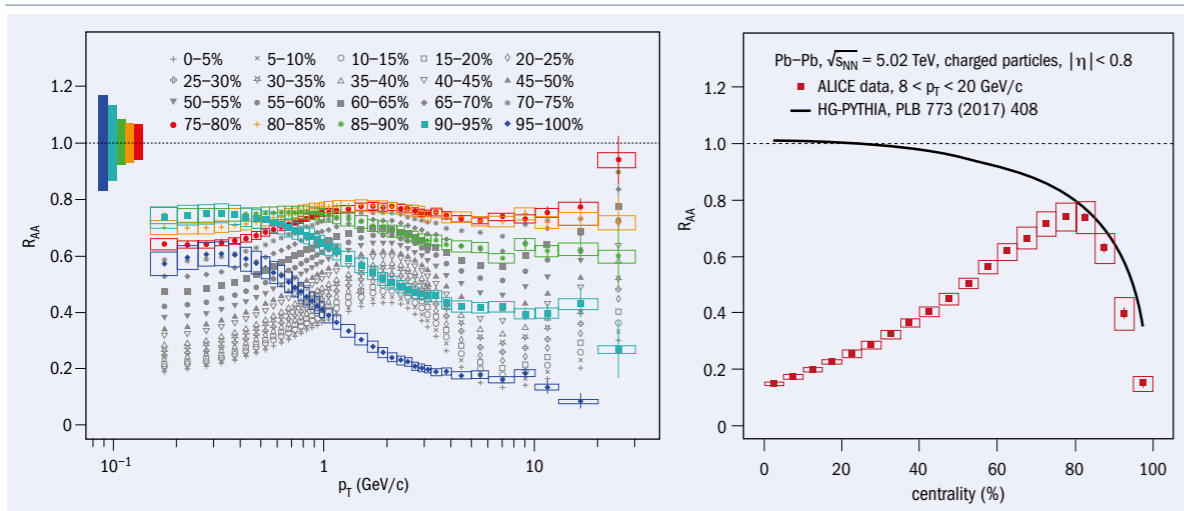

**Fig. 1.** Left: nuclear-modification factor versus  $p_T$  for 5% wide centrality classes, showing the suppression of high- $p_T$  particle production in Pb–Pb collisions. The most peripheral 25% of ion collisions (coloured) exhibit completely different behaviour from the most central 75% (grey). Coloured bars show uncertainty on the normalisation. Right: mean  $R_{AA}$  (red) compared with a new model of suppression in peripheral collisions (black).

energy densities are similar to those in peripheral Pb–Pb collisions.

The ALICE collaboration has recently put jet quenching to the test experimentally by performing a rigorous measurement of  $R_{AA}$  in narrow centrality bins. The results (figure 1, left) show that the trend of a gradual reduction in the suppression of high- $p_T$  particle production as one moves from the most central collisions (corresponding to the 0% centrality percentile) to those with a greater impact parameter does not continue above a centrality of 75%. Instead, the data show a dramatically different behaviour: increasingly strong suppression for the most peripheral collisions. The change at 75% centrality

shows that the suppression mechanism for peripheral collisions is fundamentally different from that observed in central collisions, where the suppression can be explained by parton energy loss in the QGP.

In a single Pb–Pb collision several nucleons collide. It has recently been suggested that the alignment of each nucleon collision plays an important role: if the nucleons are aligned, a single collision produces more particles, which results in a correlation between particle production at low  $p_T$ , which is used to determine the centrality, and at high  $p_T$ , where  $R_{AA}$  is measured. The suppression in the peripheral events can be modelled with a simple PYTHIA-

based model that does not implement jet–quenching effects, but incorporates the biases originating from the alignment of the nucleons, yielding qualitative agreement above 75% centrality (figure 1, right).

These results demonstrate that with the correct treatment of biases from the parton–parton interactions the observed suppression in Pb–Pb collisions is consistent with results from p–Pb collisions at similar multiplicities – an important new insight into the nuclear modification factor in small systems.

**Further reading**  
ALICE Collaboration 2018 arXiv 1805.05212 (submitted to *Phys. Lett. B*).

## CMS

# Boosting searches for fourth-generation quarks

Ever since the 1970s, when the third generation of quarks and leptons began to emerge experimentally, physicists have asked if further generations await discovery. One of the first key results from the Large Electron–Positron Collider 30 years ago provided evidence to the contrary, showing that there are only three generations of neutrinos. The discovery of the Higgs boson in 2012 added a further wrinkle to the story: many theorists believe that the mass of the Higgs boson is unnaturally small if there are additional generations of quarks heavier than the top quark.

But a loophole arises if the new heavy quarks do not interact with the Higgs field in the same way as regular quarks. The search for new heavy fourth-generation quarks – denoted  $T$  – is therefore the subject of active research at the LHC today.

CMS researchers have recently completed a search for such “vector-like” quarks using a new machine-learning method that exploits special relativity in a novel way. If the new  $T$  quarks exist, they are expected to decay to a quark and a  $W$ ,  $Z$  or Higgs boson. As top quarks and  $W/Z/H$  bosons decay

**A loophole arises if the new heavy quarks do not interact with the Higgs field in the same way**

themselves, production of a  $T$  quark–antiquark pair could lead to dozens of different final states. While most previous searches focused on a handful of channels at most, this new analysis is able to search for 126 different possibilities at once.

The key to classifying all the various final states is the ability to identify high-energy top quarks, Higgs bosons, and  $W$  and  $Z$  bosons that decay into jets of particles recorded by the detector. In the reference frame of the CMS detector, these particles produce wide jets that all look alike, but things look very

different in a frame of reference in which the initial particle (a  $W$ ,  $Z$  or  $H$  boson, or a top quark) is at rest. For example, in the centre-of-mass frame of a Higgs boson, it would appear as two well-collimated back-to-back jets of particles, whereas in the reference frame of the CMS detector the jets are no longer back-to-back and may indeed be difficult to identify as separate at all. This feature, based on special relativity, tells us how to distinguish “fat” jets originating from different initial particles.

Modern machine-learning techniques were used to train a deep neural-network classification algorithm using simulations of the expected particle decays. Several dozen properties of the jets were calculated in different hypothetical reference frames, and fed to the network, which classifies the original fat

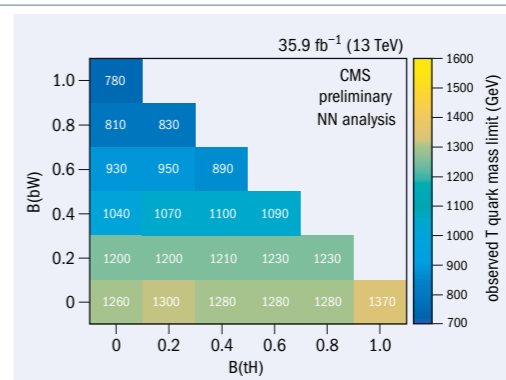

**Fig. 1.** Mass limits for  $T$  quarks in GeV. The limits are shown as a function of the probability to decay to a  $b$  quark and a  $W$  boson, versus the probability to decay to a top quark and a Higgs boson, assuming all other decays are to a top quark and a  $Z$  boson.

jets as coming from either top quarks,  $H$ ,  $W$  or  $Z$  bosons,  $b$  quarks, light quarks, or gluons. Each event is then classified according to how many of each jet type there are in the event. The number of observed events in each category was then compared to the predicted background yield: an excess could indicate  $T$ -quark pair production.

CMS found no evidence for  $T$ -quark pair production in the 2016 data, and has excluded  $T$ -quark masses up to 1.4 TeV (figure 1). The collaboration is working on new ideas to improve the classification method and extend the search to higher masses using the four-times larger 2017 to 2018 dataset.

**Further reading**  
CMS Collaboration 2018 CMS–PAS–B2G–18–005.

## ATLAS

# Pushing the limits on supersymmetry

Supersymmetry (SUSY) introduces a new fermion–boson symmetry that gives rise to supersymmetric “partners” of the Standard Model (SM) particles, and “naturally” leads to a light Higgs boson with mass close to that of the  $W$  and  $Z$ . SUSY partners that are particularly relevant in these “natural SUSY” scenarios are the top and bottom squarks, as well as the SUSY partners of the weak SM bosons, the neutralinos and charginos.

Despite the theory’s many appealing features, searches for SUSY at the LHC and elsewhere have so far yielded only exclusion limits. With LHC Run 2 completed as of the end of 2018, the ATLAS experiment has recorded 139  $\text{fb}^{-1}$  of physics-quality proton–proton collisions at a centre-of-mass energy of 13 TeV. Three recent ATLAS SUSY searches highlight the significant increase in sensitivity offered by this dataset.

The first search took advantage of refinements in  $b$ -tagging to search for light bottom squarks decaying into bottom quarks, Higgs bosons and the lightest SUSY partner, which is assumed to be invisible and stable (a candidate for dark matter). The data agree with the SM and lead to significantly improved constraints, with bottom squark masses now excluded up to 1.5 TeV.

If the accessible SUSY particles can only be produced via electroweak processes, the resulting low-production cross sections present a challenge. The second search focuses on such electroweak SUSY signatures with

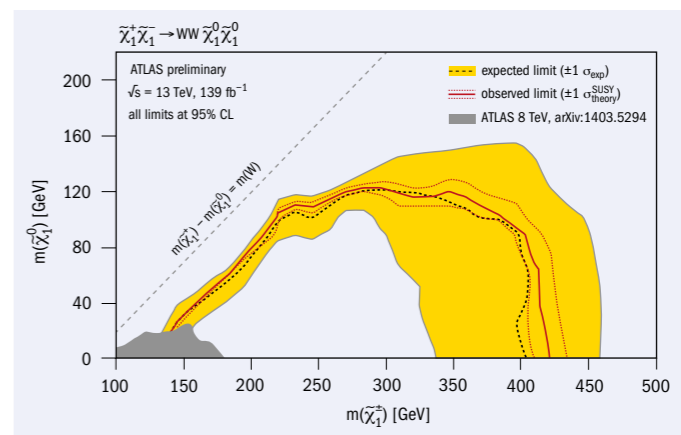

**Fig. 1.** New constraints (red) on a simplified SUSY model describing the production of a pair of charginos that both subsequently decay to a  $W$  boson and the lightest neutralino – a stable and invisible SUSY particle. The new sensitivity is significantly improved over that of the previous analysis (grey).

two charged leptons and a significant amount of missing momentum carried away by a pair of the lightest SUSY partners. The current search places strong constraints on SUSY models with light charginos and more than doubles the sensitivity of the previous analysis (figure 1).

A third recent analysis considered less conventional signatures. Top squarks – the bosonic SUSY partner of the top quark – may evade detection if they have a long lifetime and decay at macroscopic distances from the collision point. This search looked for SUSY particles decaying to a quark and a muon, looking primarily for long-lived top squarks that decayed several millimetres into

**There remains plenty of room for discovery in mining the riches from the LHC**

the detector volume. The observed results are consistent with the background-only expectation.

These analyses represent just the beginning of a large programme of SUSY searches using the entirety of the Run-2 dataset. With a rich signature space left to explore, there remains plenty of room for discovery in mining the riches from the LHC.

**Further reading**  
ATLAS Collaboration 2019 ATLAS–CONF–2019–011.  
ATLAS Collaboration 2019 ATLAS–CONF–2019–008.  
ATLAS Collaboration 2019 ATLAS–CONF–2019–006.



# FIELD NOTES

Reports from events, conferences and meetings

RENCONTRES DE MORIOND

## Standard Model stands strong at Moriond

The 66th Rencontres de Moriond, held in La Thuile, Italy, took place from 16 to 30 March, with the first week devoted to electroweak interactions and unified theories, and a second week to QCD and high-energy interactions. More than 200 physicists took part, presenting new results from precision Standard Model (SM) measurements to new exotic quark states, flavour physics and the dark sector.

A major theme of the electroweak session was flavour physics, and the star of the show was LHCb's observation of CP violation in charm decays (see p7). The collaboration showed several other new results concerning charm- and B-meson decays. One much anticipated result was an update on  $R_K$ , the ratio of rare decays of a B<sup>-</sup> to electrons and muons, using data taken at energies of 7, 8 and 13 TeV. These decays are predicted to occur at the same rate to within 1%; previous data collected are consistent with this prediction but favour a lower value, and the latest LHCb results continue to support this picture. Together with other measurements, these results paint an intriguing picture of possible new physics (p33) that was explored in several talks by theorists.

### Run-2 results

The LHC experiments presented many new results based on data collected during Run 2. ATLAS and CMS have measured most of the Higgs boson's main production and decay modes with high statistical significance and carried out searches for new, additional Higgs bosons. From a combination of all Higgs-boson measurements, ATLAS obtained new constraints on the important Higgs self-coupling, while CMS presented updated results on the Higgs decay to two Z bosons and its coupling to top quarks.

Precision SM studies continued with first evidence from ATLAS for the simultaneous production of three W or Z bosons, and CMS presented first evidence for the production of two W bosons in two simultaneous interactions between colliding partons. The very large new dataset has also allowed ATLAS and CMS to expand their searches for new physics, setting stronger lower limits on the



LHCb continued to enjoy the limelight during Moriond's QCD session, announcing the discovery of a new five-quark hadron, named  $P_c(4312)^+$ , which decays to a proton and a  $J/\psi$  and is a lighter companion of the pentaquark structures revealed by LHCb in 2015 (p15). The result is expected to motivate deeper studies of the structure of these and other exotic hadrons. Another powerful way to delve into the depths of QCD, addressed during the second week of the conference, is via the B<sub>s</sub> meson family. Following the observation of the B<sub>s</sub>(2S) by ATLAS in 2014, CMS reported the existence of a two-peak feature in data corresponding to the B<sub>s</sub>(2S) and the B<sub>s</sub>'(2S) – supported by new results from LHCb based on its full 2011–2018 data sample. Independent measurements of CP violation in the B<sub>s</sub> system reported by ATLAS and LHCb during the electroweak session were also combined to yield the most precise measurement yet, which is consistent with the small value predicted by the SM.

### Mountain encounters

Flavour physics took centre stage at Moriond this year.

allowed mass ranges of supersymmetric and other hypothetical particles (see pp16–17). These also include new limits from CMS on the parameters describing slowly moving heavy particles, and constraints from both collaborations on the production rate of Z' bosons. ATLAS, using the results of lead-ion collisions taken in 2018, also reported the observation of light-by-light scattering – a very rare process that is forbidden by classical electrodynamics.

New results and prospects in the neutrino sector were communicated, including Daya Bay and the reactor antineutrino flux anomaly, searches for neutrinoless double-beta decay, and the reach of T2K and NOvA in tackling the neutrino mass hierarchy and leptonic CP violation. Dark matter, axions and cosmology also featured prominently. New results from experiments such as XENON1T, ABRACADABRA, SuperCDMS and ATLAS and CMS illustrate the power of multi-prong dark-matter searches – not just for WIMPs but also very light or exotic candidates. Cosmologist Lisa Randall gave a broad-reaching talk about “post-modern cosmology”, in which she argued that – as in particle physics – the easy times are probably over and that astronomers need to look at more subtle effects to break the impasse.

Moriond electroweak also introduced a new session: “feeble interactions”, which was designed to reflect the growing interest in very weak processes at the LHC and future experiments.

### A charmed life

In the heavy-ion arena, ALICE highlighted its observation that baryons containing charm quarks are produced more often in proton-proton collisions than in electron-positron collisions. Initial measurements in lead-lead collisions suggest an even higher production rate for charmed baryons, similar to what has been observed for strange baryons. These results indicate that the presence of quarks in the colliding beams affects the hadron production rate. The collaboration also presented the first measurement of the triangle-shaped flow of  $J/\psi$  particles in lead-lead collisions, showing that even heavy quarks are affected by the quarks and gluons in the quark-gluon plasma and retain some memory of the collisions' initial geometry.

The SM still stands strong after Moriond 2019, and the observation of CP violation in D mesons represents another victory, concluded Shahram Rahatlou of Sapienza University of Rome in the experimental summary. “But the flavour anomaly is still there to be pursued at low and high mass.”

The star of the show was LHCb's observation of CP violation in charm decays

Matthew Chalmers CERN, with input from the LHC experiment collaborations.

CERN COURIER MAY/JUNE 2019

19

**FAGOR**  
FAGOR AUTOMATION

Open  
to your  
world



100TH ANNIVERSARY OF THE BIRTH OF RICHARD FEYNMAN

## Centennial conference honours Feynman

2018 marked the 100th anniversary of the birth of Richard Feynman. As one of several events worldwide celebrating this remarkable figure in physics, a memorial conference was held at the Institute of Advanced Studies at Nanyang Technological University in Singapore from 22 to 24 October, co-chaired by Lars Brink, KK Phua and Frank Wilczek. The format was one-hour talks with 45 minute discussions.

Pierre Ramond began the conference with anecdotes from his time as Feynman's next-door neighbour at Caltech. He discussed Feynman the MIT undergraduate, his first paper and his work at Princeton as a graduate student. There, Feynman learnt about Dirac's idea of summing over histories from Herbert Jehle. Jehle asked Feynman about it a few days later. He said that he had understood it and had derived the Schrödinger equation from it. Feynman's adviser was John Wheeler. Wheeler was toying with the idea of a single electron travelling back and forth in time – were you to look at a slice of time you would observe many electrons and positrons. After his spell at Los Alamos, this led Feynman to the idea of the propagator, which considers antiparticles propagating backwards in time as well as particles propagating forwards. These ideas would soon underpin the quantum description of electromagnetism – QED – for which Feynman shared the 1965 Nobel Prize in Physics with Tomonaga and Schwinger.

### Revolutionary diagrams

The propagator was the key to the eponymous diagrams Feynman then formulated to compute the Lamb shift and other quantities. At the Singapore conference, Lance Dixon exposed how Feynman diagrams revolutionised the calculation of scattering amplitudes. He offered as an example the calculation of the anomalous magnetic moment of the electron, which has now reached five-loop precision and includes 12,672 diagrams. Dixon also discussed the importance of Feynman's parton picture for understanding deep-inelastic scattering, and the staggeringly complex calculations required to understand data at the LHC.

George Zweig, the most famous of Feynman's students, and the inventor of "aces" as the fundamental constituents of matter, gave a vivid talk, recounting that it took a long time to convince a scepti-



**Feynman fest**  
Some of the biggest names in physics attended the memorial event.

**Feynman's 1981 paper was the first on quantum computers and set the ground for the present developments**

cal Feynman about them. He described life in the shadows of the great man as a graduate student at Caltech in the 1960s. At that time Feynman wanted to solve quantum gravity, and was giving a course on the subject of gravitation. He asked the students to suppose that Einstein had never lived: how would particle physicists discuss gravity? He quickly explained that there must be a spin-two particle mediating the force; by the second lecture he had computed the precession of the perihelion of Mercury, a juncture that other courses took months to arrive at. Zweig recounted that Feynman's failure to invent a renormalisable theory of quantum gravity affected him for many years. Though he did not succeed, his insights continue to resound today. As Ramond earlier explained, Feynman's contribution to a conference in Chapel Hill in 1957, his first public intervention on the subject, is now seen as the starting point for discussions on how to measure gravitational waves.

Cristiane Morais-Smith spoke on Feynman's path integrals, comparing Hamiltonian and Lagrangian formulations, and showing their importance in perturbative QED. Michael Creutz, the son of one of Feynman's colleagues at Princeton and Los Alamos, showed how the path integral is also necessary to be able to work on the inherently non-perturbative theory of quantum chromodynamics. Morais-Smith went on to illustrate how Feynman's path integrals now have a plethora of applications outside particle physics, from graphene to quantum Brownian motion and dissipative quantum tunnelling. Indeed, the conference did not neglect Feynman's famous interventions outside particle physics. Frank Wilczek recounted Feynman's famous insight that there is plenty of room at the bottom, telling of his legendary after-dinner talk in 1959

that foreshadowed many developments in nanotechnology. Wilczek concluded that there is plenty of room left in Hilbert space, describing entanglement, quantum cryptography, quantum computation and quantum simulations. Quantum computing is the last subject that Feynman worked hard on. Artur Ekert described the famous conference at MIT in 1981 when Feynman first talked about the subject. His paper from this occasion "Simulating Physics with Computers" was the first paper on quantum computers and set the ground for the present developments.

### Biology hangout

Feynman was also interested in biology for a long time. Curtis Callan painted a picture of Feynman "hanging out" in Max Delbruck's laboratory at Caltech, even taking a sabbatical at the beginning of the 1960s to work there, exploring the molecular workings of heredity. In 1969 he gave the famous Hughes Aerospace lectures, offering a grand overview of biology and chemistry – but this was also the time of the parton model and somehow that interest took over.

Robbert Dijkgraaf spoke about the interplay between art and science in Feynman's life and thinking. He pointed out how important beauty is, not only in nature, but also in mathematics, for instance whether one uses a geometric or algebraic approach. Another moving moment of this wide-ranging celebration of Feynman's life and physics was Michelle Feynman's words about growing up with her father. She showed him both as a family man and also as a scientist, sharing his enthusiasm for so many things in life.

● Recordings of the presentations are available online.

**Lars Brink** Chalmers University of Technology, Göteborg, Sweden.

FUTURE CIRCULAR COLLIDER CO-INNOVATION WORKSHOP

## Particle colliders: accelerating innovation

Around 100 researchers, academics and industry delegates joined a co-innovation workshop in Liverpool, UK, on 22 March to discuss the strategic R&D programme for a Future Circular Collider (FCC) and associated benefits for industry. Motivated by the FCC study, the aim of the event was to identify joint R&D opportunities across accelerator projects and disciplines.

New particle colliders provide industry with powerful test-beds with a high publicity factor. Well-controlled environments allow novel technologies and processes to be piloted, and SMEs are ideal partners to bring these technologies – which include superconducting magnets, cryogenics, civil engineering, detector development, energy efficiency and novel materials and material processing techniques – to maturity.

Short talks about FCC-related areas for innovation, examples of successful technology-transfer projects at CERN, as well as current and future funding opportunities stimulated interesting discussions. Several areas were identified as bases for co-innovation, including resource-efficient tunnelling, the transfer of bespoke machine-learning techniques from particle physics to industry, detector R&D, cooling and data handling. The notes from all the working groups will be used to establish joint funding bids between participants.

The co-innovation workshop was part of a bigger event, "Particle Colliders – Accelerating Innovation", which was

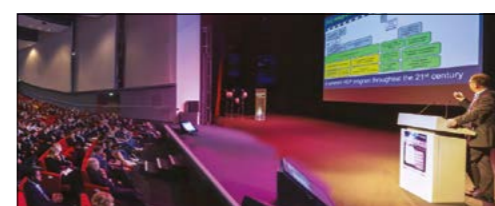

devoted to the benefits of fundamental science to society and industry, co-hosted by the University of Liverpool and CERN together with partners from the FCC and H2020 EuroCirCol projects, and supported by EU-funded MSCA training networks. Almost 1000 researchers and industrialists from across Europe, including university and high-school students, took part. An industry exhibition allowed more than 60 high-tech companies to showcase their latest products, also serving university students as a careers fair, and more than a dozen different outreach activities were available to younger students.

A separate event, held at CERN on 4 and 5 March, reviewed the FCC physics capabilities following the publication of the FCC conceptual design report in January (CERN Courier January/February 2019 p8). The FCC study envisages the construction of a new 100 km-circumference tunnel at CERN hosting an intensity-frontier lepton collider (FCC-ee) as a first step, followed by an energy-frontier hadron machine (FCC-hh). It offers substantial and model-independent studies of the

Higgs boson by extending the range of measurable Higgs properties to its total width and self-coupling. Moreover, the combination of superior precision and energy reach allows a complementary mix of indirect and direct probes of new physics. For example, FCC-ee would enable the Higgs couplings to the Z boson to be measured with an accuracy better than 0.17%, while FCC-hh will determine model-independent ttH coupling to <1%.

**Constructive collisions**  
Michael Benedikt discusses FCC's implementation plan.

Physics discussions were accompanied by a status report of the overall FCC project, reviewing the technological challenges for both accelerator and detectors, the project implementation strategy, and cost estimates. Construction of the more technologically ready FCC-ee could start by 2028, delivering first physics beams a decade later, right after the end of the HL-LHC programme. Another important aspect of the two-day meeting was the need for further improving theoretical predictions to match the huge step in experimental precision possible at the FCC.

Planning now for a 70-year-long programme may sound a remote goal. However, as Alain Blondel of the University of Geneva remarked in the concluding talk of the conference, the first report on the LHC dates back more than 40 years. "Progress in knowledge has no price," he said. "The FCC sets ambitious but feasible goals for the global community resembling previous leaps in the long history of our field."

**Panos Charitos** CERN.

ALEGRO WORKSHOP

## Upping the tempo on wakefield accelerators

Around 50 experts from around the world met at CERN from 26 to 29 March for the second ALEGRO workshop to discuss advanced linear-collider concepts at the energy frontier.

ALEGRO, the Advanced Linear Collider Study Group, was formed as an outcome of an ICFE workshop on advanced accelerators held at CERN in 2017 (CERN Courier December 2017 p31). Its purpose is to unite the accelerator community behind a >10 TeV electron-positron collider based on advanced and novel accelerators (ANAs), which use wakefields driven by intense laser



**Advanced accelerators**  
Experts met at CERN in March.

pulses or relativistic particle bunches in plasma, dielectric or metallic structures to reach gradients as high as 1 GeV/m. The proposed Advanced Linear International Collider – ALIC for short – would be shorter than linear colliders based on more conventional acceleration technologies such as CLIC and ILC, and would reach higher energies.

The main research topics ALEGRO identified are the preservation of beam quality, the development of stable and

efficient drivers (in particular laser systems), wall-plug-to-beam-power efficiency, operation at high-repetition rates, tolerance studies, the staging of two structures and the development of suitable numerical tools to allow for the simulation of the accelerator as a whole.

The next ALEGRO workshop will be held in March 2020 in Germany.

**Patric Muggli** Max Planck Institute for Physics, Munich, Germany.



# Best Cyclotron Systems

Best Cyclotron Systems provides 15/20/25/30/35/70 MeV Proton Cyclotrons as well as 35 & 70 MeV Multi-Particle (Alpha, Deuteron & Proton) Cyclotrons

- Currents from 100uA to 1000uA (or higher) depending on the particle beam are available on all BCS cyclotrons
- Best 20u to 25 and 30u to 35 are fully upgradeable on site

Cyclotron	Energy (MeV)	Isotopes Produced
Best 15	15	<sup>18</sup> F, <sup>99m</sup> Tc, <sup>11</sup> C, <sup>13</sup> N, <sup>15</sup> O, <sup>64</sup> Cu, <sup>67</sup> Ga, <sup>124</sup> I, <sup>103</sup> Pd
Best 20u/25	20, 25–15	Best 15 + <sup>123</sup> I, <sup>111</sup> In, <sup>68</sup> Ge/ <sup>68</sup> Ga
Best 30u (Upgradeable)	30	Best 15 + <sup>123</sup> I, <sup>111</sup> In, <sup>68</sup> Ge/ <sup>68</sup> Ga
Best 35	35–15	Greater production of Best 15, 20u/25 isotopes plus <sup>201</sup> Tl, <sup>81</sup> Rb/ <sup>81</sup> Kr
Best 70	70–35	<sup>82</sup> Sr/ <sup>82</sup> Rb, <sup>123</sup> I, <sup>67</sup> Cu, <sup>81</sup> Kr + research



Installation of Best 70 MeV Cyclotron at INFN, Legnaro, Italy

## Best ABT Molecular Imaging

The BG-75 Biomarker Generator is a revolutionary development in radio-pharmaceutical production that delivers a single or batch dose of <sup>18</sup>F-FDG, and additional advanced <sup>18</sup>F biomarkers on demand. The system provides integration of all components needed to produce and qualify PET biomarkers into a single, self-contained system that occupies a fraction of the space required by conventional solutions, simplifying the implementation of PET.



TeamBest Companies © 2019

## Best Particle Therapy

400 MeV Rapid Cycling Medical Synchrotron for Proton-to-Carbon Heavy Ion Therapy:

- Intrinsically small beams facilitating beam delivery with precision
- Small beam sizes – small magnets, light gantries – smaller footprint
- Highly efficient single turn extraction
- Efficient extraction – less shielding
- Flexibility – heavy ion beam therapy (protons and/or carbon), beam delivery modalities



\* Best iRCMS is under development and not available for sale currently.

www.bestcyclotron.com • www.bestabt.com • www.bestproton.com  
BCS tel: 604 681 3327 • Best ABT tel: 865 982 0098 • BPT tel: 703 451 2378

### VIENNA CONFERENCE ON INSTRUMENTATION

## Cross-fertilisation in detector development

More than 300 experts convened from 18–22 February for the 15th Vienna Conference on Instrumentation to discuss ongoing R&D efforts and set future roadmaps for collaboration. “In 1978 we discussed wire chambers as the first electronic detectors, and now we have a large number of very different detector types with performances unimaginable at that time,” said Manfred Krammer, head of CERN’s experimental physics department, recalling the first conference of the triennial series. “In the long history of the field we have seen the importance of cross-fertilisation as developments for one specific experiment can catalyse progress in many fronts.”

Following this strong tradition, the conference covered fundamental and technological issues associated with the most advanced detector technologies as well as the value of knowledge transfer to other domains. Over five days, participants covered topics ranging from sensor types and fast and efficient electronics to cooling technologies and their mechanical structures.

Contributors highlighted experiments proposed in laboratories around

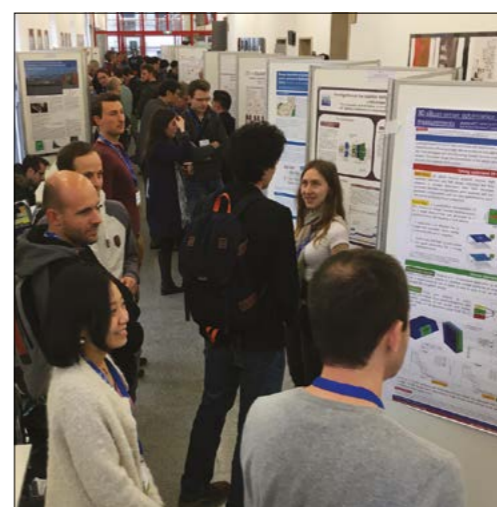

**Instrumental contributions** The Vienna conference cultivates the next generation of detector experts.

the world, spanning gravitational-wave detectors, colliders, fixed-target experiments, dark-matter searches, and neutrino and astroparticle experiments. A number of talks covered upgrade activities for the LHC experiments ahead of

LHC Run 3 and for the high-luminosity LHC. An overview of LIGO called for serious planning to ensure that future ground-based gravitational-wave detectors can be operational in the 2030s. Drawing a comparison between the observation of gravitational waves and the discovery of the Higgs boson, Christian Joram of CERN noted “Progress in experimental physics often relies on breakthroughs in instrumentation that lead to substantial gains in measurement accuracy, efficiency and speed, or even open completely new approaches.”

Beyond innovative ideas and cross-disciplinary collaboration, the development of new detector technologies calls for good planning of resources and times. The R&D programme for the current LHC upgrades was set out in 2006, and it is already timely to start preparing for the third long shutdown in 2023 and the High-Luminosity LHC. Meanwhile, the CLIC and Future Circular Collider studies are developing clear ideas of the future experimental challenges in tackling the next exploration frontier.

Panos Charitos CERN.

### PHYSTAT-NU

## Neutrino connoisseurs talk stats at CERN

PHYSTAT-nu 2019 was held at CERN from 22 to 25 January. Counted among the 130 participants were LHC physicists and professional statisticians as well as neutrino physicists from across the globe. The inaugural meeting took place at CERN in 2000 and PHYSTAT has gone from strength to strength since, with meetings devoted to specific topics in data analysis in particle physics. The latest PHYSTAT-nu event is the third of the series to focus on statistical issues in neutrino experiments. The workshop focused on the statistical tools used in data analyses, rather than experimental details and results.

Modern neutrino physics is geared towards understanding the nature and mixing of the three neutrinos’ mass and flavour eigenstates. This mixing can be inferred by observing “oscillations” between flavours as neutrinos travel through space. Neutrino experiments come in many different types and scales, but they tend to have one calculation in common: whether the neutrinos



Statistically significant PHYSTAT-nu 2019 brought neutrino physicists together with statisticians and LHC physicists.

are created in an accelerator, a nuclear reactor, or by any number of astrophysical sources, the number of events expected in the detector is the product of the neutrino flux and the interac-

tion cross section. Given the ghostly nature of the neutrino, this calculation presents subtle statistical challenges. To cancel common systematics, many facilities have two or more detectors >

FIELD NOTES

at different distances from the neutrino source. However, as was shown for the NOVA and T2K experiments, competitors to observe CP violation using an accelerator-neutrino beam, it is difficult to correlate the neutrino yields in the near and far detectors. A full cancellation of the systematic uncertainties is

**Lessons can be learnt from the LHC experience**

complicated by the different detector acceptances, possible variations in the detector technologies, and the compositions of different neutrino interaction modes. In the coming years these two experiments plan to combine their data in a global analysis to increase their discovery power – lessons can be learnt

from the LHC experience.

The problem of modelling the interactions of neutrinos with nuclei – essentially the problem of calculating the cross section in the detector – forces researchers to face the thorny statistical challenge of producing distributions that are unadulterated by detector effects. Such “unfolding” corrects kinematic observables for the effects of detector acceptance and smearing, but correcting for these effects can cause huge uncertainties. To counter this, strong “regularisation” is often applied, biasing the results towards the smooth spectra of Monte Carlo simulations. The desirability of publishing unregularised results as well as unfolded measurements was agreed by PHYSTAT-nu attendees. “Response matrices” may also be released, allowing physicists outside of an experimental collaboration to smear their own models, and compare them to detector-level data. Another major issue in modeling neutrino-nuclear interactions is the “unknown unknowns”. As Kevin McFarland of the University of Rochester reflected in his summary talk, it is important not to estimate your uncertainty by a survey of theory models. “It’s

**A major issue in modeling neutrino-nuclear interactions is the “unknown unknowns”**

like trying to measure the width of a valley from the variance of the position of sheep grazing on it. That has an obvious failure mode: sheep read each other’s papers.”

An important step for current and future neutrino experiments could be to set up a statistics committee, as at the Tevatron, and, more recently, the LHC experiments. This PHYSTAT-nu workshop could be the first real step towards this exciting scenario.

The next PHYSTAT workshop will be held at Stockholm University from 31 July to 2 August on the subject of statistical issues in direct-detection dark-matter experiments.

**Olaf Behnke** DESY,  
**Louis Lyons** University of Oxford and  
**Davide Sgalaberna** CERN.



**WORLD LEADERS IN MANUFACTURING HIGH PRECISION ELECTROMAGNETS AND ASSOCIATED ACCELERATOR COMPONENTS**

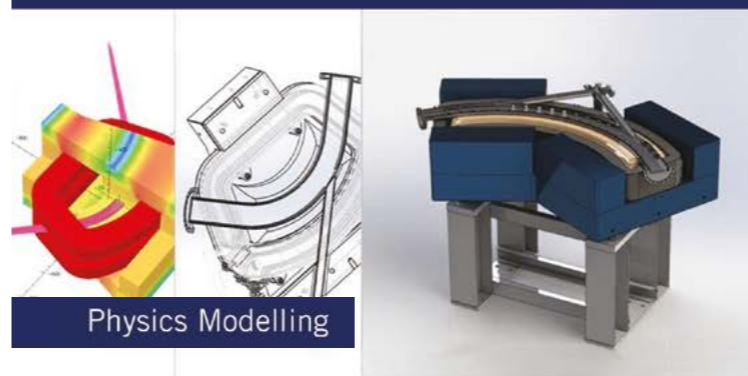

Physics Modelling



Discovery Science - UHV Chamber



Quality Production

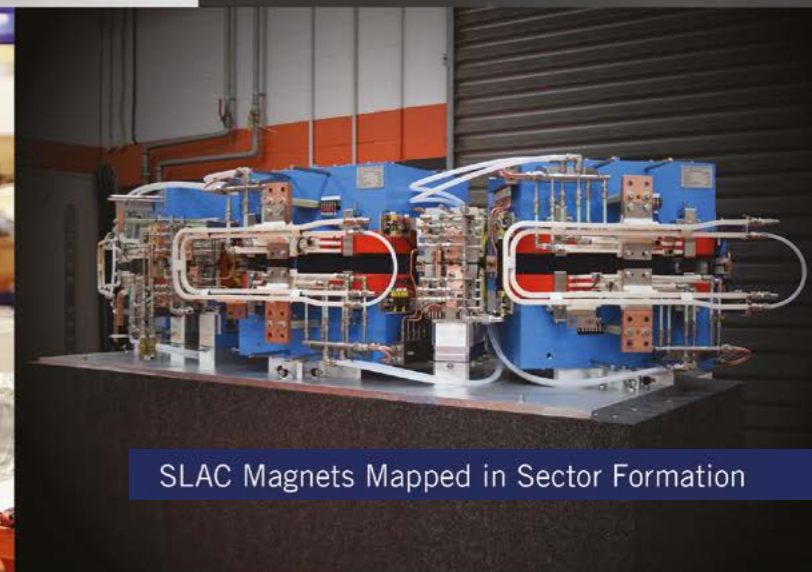

SLAC Magnets Mapped in Sector Formation

MAGNETS UHV VACUUM CHAMBERS RF RESONATORS  
BEAMLINE INSTRUMENTS ION SOURCES PHYSICS DESIGN  
MECHANICAL DESIGN MANUFACTURE VERIFICATION



M2p.65xx

**M2p series**

**New AWG series: smaller, faster, better!**

**5 YEARS WARRANTY**

- 16 bit resolution with 40 MS/s and 125 MS/s
- 6 product variations with 1 to 4 channels
- Output level  $\pm 3$  V (50  $\Omega$ ) or  $\pm 6$  V (1 M $\Omega$ )
- Fast PCIe x4 interface with 700 MByte/s streaming

**SPECTRUM INSTRUMENTATION**

Perfect fit – modular designed solutions

Europe / Asia: Phone +49 (4102) 695 60 | US: Phone (201) 562 1999  
[www.spectrum-instrumentation.com](http://www.spectrum-instrumentation.com)

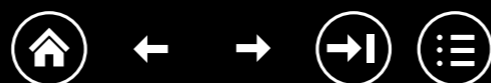

# ELECTRON GUN SYSTEMS

Flood Beams, Small Spot, High Brightness LaB<sub>6</sub>  
Ultra-fast ps to fs Photo Emission Guns  
1 eV to 100 keV

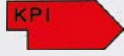

www.kimballphysics.com



**UHV MULTI-CF FITTINGS**  
Some of the over 100 Available  
Customs Encouraged  
Metric Available



# RUTHERFORD, TRANSMUTATION AND THE PROTON

FEATURE PROTON CENTENARY

The events leading to Ernest Rutherford's discovery of the proton, published in 1919.



Nuclear giant Ernest Rutherford in Canada in 1907.

In his early days, Ernest Rutherford was the right man in the right place at the right time. After obtaining three degrees from the University of New Zealand, and with two years' original research at the forefront of the electrical technology of the day, in 1895 he won an Exhibition of 1851 Science Scholarship, which took him to the Cavendish Laboratory at the University of Cambridge in the UK. Just after his arrival, the discoveries of X-rays and radioactivity were announced and J J Thomson discovered the electron. Rutherford was an immediate believer in objects smaller than the atom. His life's work changed to understanding radioactivity and he named the alpha and beta rays.

In 1898 Rutherford took a chair in physics at McGill University in Canada, where he achieved several seminal results. He discovered radon, demonstrated that radio-activity was just the natural transmutation of certain elements, showed that alpha particles could be deviated in electric and magnetic fields (and hence were likely to be helium atoms minus two electrons), dated minerals and determined the age of the Earth, among other achievements.

In 1901, the McGill Physical Society called a meeting titled "The existence of bodies smaller than an atom". Its aim was to demolish the chemists. Rutherford spoke to the motion and was opposed by a young Oxford chemist, Frederick Soddy, who was at McGill by chance. Soddy's address "Chemical evidence for the indivisibility of the atom" attacked physicists, especially Thomson and Rutherford, who "... have been known to give expression to opinions on chemistry in general and the atomic theory in particular which call for strong protest." Rutherford invited Soddy, who specialised in gas analysis, to join him. It was a short but fruitful collaboration in which the pair determined the first few steps in the natural transmutation of the heavy elements.

### Manchester days

For some years Rutherford had wished to be more in the centre of research, which was Europe, and in 1907 moved to the University of Manchester. Here he began to follow up on experiments at McGill in which he had noted that a beam of alpha particles became fuzzy if passed through air

KIMBALL PHYSICS



50 Years of Good Physics

# CERN COURIER

VOLUME 59 NUMBER 3 MAY/JUNE 2019

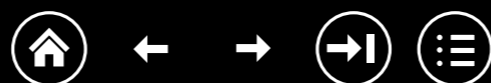

IOP Publishing







**INSTRUMENTATION TECHNOLOGIES**



**LIBERA**



**MEET INSTRUMENTATION TECHNOLOGIES, INTERTWINING A STRONG PORTFOLIO OF BRANDS AND EXPERTISE FOR 20+ YEARS.**



**MEET LIBERA, PROVIDER OF SOLUTIONS FOR PARTICLE ACCELERATORS, TRAINED IN INSTRUMENTATION TECHNOLOGIES.**

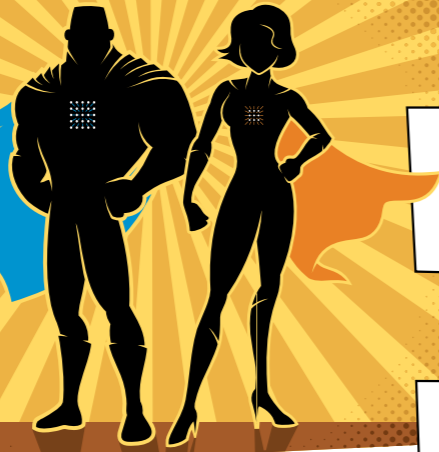





**OFFERS CUTTING EDGE SOLUTIONS ON TECHNOLOGICALLY DEMANDING FIELDS.**



**OFFERS EXPERT DOMAIN AND APPLICATION KNOWLEDGE TO SUPPORT OUR USERS.**





**INTRODUCING LIBERA'S LATEST GADGET OF CHOICE**



**LIBERA DIGIT 500**

- 4 channel digitizer with 500 MSps / 14 bit ADCs
- >80dB of dynamic range and 31dB of variable attenuation
- ADC sampling phase locked to external reference signal
- passive cooled and boot from micro-SD card
- EPICS/Tango/Python available interfaces
- ready to be used with CSS GUI



Instrumentation Technologies, d.o.o. / Velika pot 22, SI-5250 Solkan, Slovenia / e: sales@i-tech.si / w: www.i-tech.si

**RIDDLE FOR ANCIENT ALCHEMISTS SOLVED**

Sir Ernest Rutherford Said to Transmute Matter

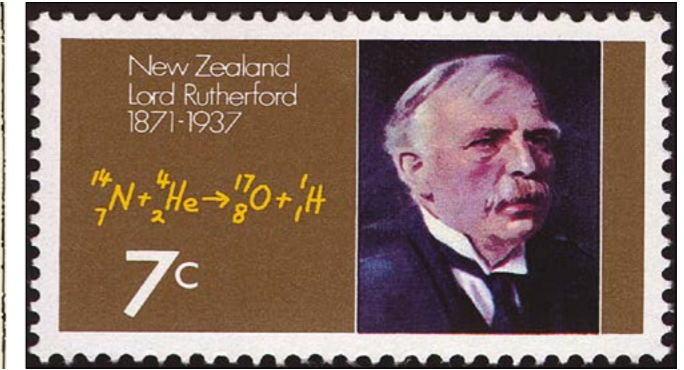

**Atomic history**  
How the Boston Globe reported the discovery of the proton on 8 December 1919 (left), and a commemorative New Zealand stamp from 1971 (right).

or a thin slice of mica. They were scattered by an angle of about two degrees, indicating the presence of electric fields of 100 MV/cm, prompting his statement that “the atoms of matter must be the seat of very intense electrical forces”.

At Manchester he inherited an assistant, Hans Geiger, who was soon put to work making accurate measurements of the number of alpha particles scattered by a gold foil over these small angles. Geiger, who trained the senior undergraduates in radioactive techniques, told Rutherford in 1909 that one, Ernest Marsden, was ready for a subject of his own. Everyone knew that beta particles could be scattered off a block of metal, but no one thought that alpha particles would be. So Rutherford told Marsden to examine this. Marsden quickly found that alpha particles are indeed scattered – even if the block of metal was replaced by Geiger’s gold foils. This was entirely unexpected. It was, as Rutherford later declared, as if you fired a 15 inch naval shell at a piece of tissue paper and it came back and hit you.

One day, a couple of years later, Rutherford exclaimed to Geiger that he knew what the atom looked like: a nuclear structure with most of the mass and all of one type of charge in a tiny nucleus only a thousandth the size of an atom. This is the work for which he is most famous today, eight decades after his death (CERN Courier May 2011 p20).

Around 1913, Rutherford asked Marsden to “play marbles” with alphas and light atoms, especially hydrogen. Classical calculations showed that an alpha colliding head-on with a hydrogen nucleus would cause the hydrogen to recoil with a speed 1.6 times, and a range four times, that of the alpha particle that struck it. The recoil of the less-massive, less-charged hydrogen could be detected as lighter flashes on the scintillation screen at much greater range than the alphas could travel. Marsden indeed observed such long-range “H” particles, as he named them, produced in hydrogen gas and in thin films of materials rich in hydrogen, such as paraffin wax. He also noticed that the long-ranged H particles were sometimes produced when alpha particles travelled through air, but he did not know where they came from: water vapour in the gas, absorbed water on the apparatus or even emission from the alpha source, were suggested.

Mid-1914 bought an end to the collaboration. Marsden wrote up his work before accepting a job in New Zealand. Meanwhile, Rutherford had sailed to Canada and the US to give lectures, spending just a month back at Manchester

before heading to Australia for the annual meeting of the British Association for the Advancement of Science. Three days before his arrival, war was declared in Europe.

**Splitting the atom**

Rutherford arrived back in Manchester in January 1915, via a U-boat-laced North Atlantic. It was a changed world, with the young men off fighting in the war. On behalf of the Admiralty, Rutherford turned his mind to one of the most pressing problems of the war: how to detect submarines when submerged. His directional hydrophone (patented by Bragg and Rutherford) was to be fitted to fleet ships. It was not until 1917 when Rutherford could return to his scientific research, specifically alpha-particle scattering from light atoms. By December of that year, he reported to Bohr that “I am also trying to break up the atom by this method. – Regard this as private.”

He studied the long-range hydrogen-particle recoils in several media (hydrogen gas, solid materials with a lot of hydrogen present and gases such as CO<sub>2</sub> and oxygen), and was surprised to find that the number of these “recoil” particles increased when air or nitrogen was present. He deduced that the alpha particle had entered the nucleus of the nitrogen atom and a hydrogen nucleus was emitted. This marked the discovery that the hydrogen nucleus – or the proton, to give it the name coined by Rutherford in 1920 – is a constituent of larger atomic nuclei.

Marsden was again available to help with the experiments for a few months from January 1919, whilst awaiting transport back to New Zealand after the war, and that year Rutherford accepted the position of director of the Cavendish Laboratory. Having delayed publication of the 1917 results until the war ended, Rutherford produced four papers on the light-atom work in 1919. In the fourth, “An anomalous effect in nitrogen.”, he wrote “we must conclude that the nitrogen atom disintegrated ... and that the hydrogen atom which is liberated formed a constituent part of the nitrogen nucleus.” He also stated: “Considering the enormous intensity of the forces brought into play, it is not so much a matter of surprise that the nitrogen atom should suffer disintegration as that the alpha particle itself escapes disruption into its constituents”.

In 1920 Rutherford first proposed building up atoms from stable alphas and H ions. He also proposed that a particle of mass one but zero charge had to exist (neutron) to account

FEATURE PROTON CENTENARY

for isotopes. With Wilson's cloud chamber he had observed branched tracks of alpha particles at the end of their range. A Japanese visitor, Takeo Shimizu, built an automated Wilson cloud chamber capable of being expanded several times per second and built two cameras to photograph the tracks at right angles. Patrick Blackett, after graduating in 1921, took over the project when Shimizu returned to Japan. After modifications, by 1924, he had some 23,000 photographs showing some 400,000 tracks. Eight were forked, confirming Rutherford's discovery. As Blackett later wrote: "The novel result deduced from these photographs was that the  $\alpha$  was itself captured by the nitrogen nucleus with the ejection of a hydrogen atom, so producing a new and then unknown isotope of oxygen,  $^{17}\text{O}$ ."

As Blackett's work confirmed, Rutherford had split the atom, and in doing so had become the world's first successful alchemist, although this was a term that he did not like very much. Indeed, he also preferred to use the word "disintegration" rather than "transmutation". When Rutherford and Soddy realised that radioactivity caused an element to naturally change into another, Soddy has written that he yelled "Rutherford, this is transmutation: the thorium is disintegrating and transmuting itself into argon (sic) gas." Rutherford replied, "For Mike's sake, Soddy, don't call it transmutation. They'll have our heads off as alchemists!"

In 1908 Rutherford had been awarded the Nobel Prize in Chemistry "for his investigations into the disintegration of the elements, and the chemistry of radioactive substances".

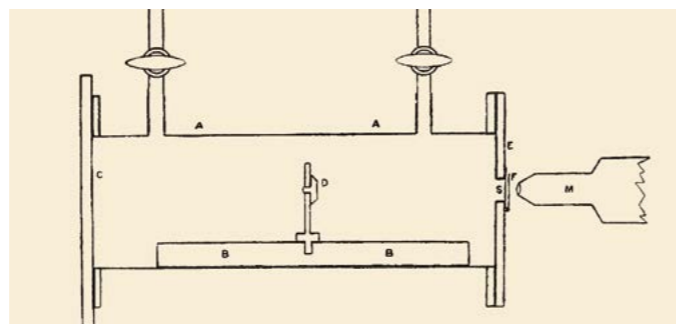

**Experimental sketch** Rutherford's apparatus for splitting the atom, showing the alpha emitter (D), which could be slid along B; metal absorbers equivalent to the stopping power of about 5 cm of air (S); and the ZnS scintillation screen (F).

There was never a second prize for his detection of individual alpha particles, unearthing the nuclear structure of atoms, or the discovery of the proton. But few would doubt the immense contributions of this giant of physics. ●

**Further reading**

J Campbell 1999 *Rutherford Scientist Supreme* (AAS Publications).

A Romer 1997 *Am. J. Phys.* **65** 707.

E Rutherford 1919 *Philos. Mag.* **37** 581.

**THE AUTHOR**

**John Campbell**  
University of  
Canterbury,  
New Zealand.



High Performance Metal Solutions

**High Performance Solutions for Particle Accelerators**

H.C. Starck's global supply chain offers semi-finished, finished and fully machined products for high energy physics projects:

- > Collimators
- > Radiation Shielding
- > Targets
- > Beam Blockers
- > Shutters

From pure and alloyed refractory metals:

- > Molybdenum
- > Tungsten
- > Niobium
- > Tantalum

Fabrications are available in a wide range of flat and round products:

- > Plate, Sheet, Foil

Superconducting wire bundles are manufactured from niobium and tantalum bar and foils with toll extrusion services for the large diameter bundles.



moreinfo@hstarck.com

## TECNOMECC

PRINTED CIRCUIT BOARDS

CERN'S OMOLOGATED PCB SUPPLIER

MULTILAYERS UP TO 32 LAYERS

HF-RF-MICROWAVE and HIGH T<sub>g</sub> MATERIALS

FLEX, RIGID-FLEX, TEFLON, METAL CORE

HIGH POWER APPLICATIONS-THERMAL MANAGEMENT

FINE LINE, MICRODRILLING BLIND AND BURIED

UL HALOGEN FREE MATERIALS

FLEX PCB SIZE UP TO 7 METERS

FAST PCBA (COMPONENT ASSEMBLY SERVICE)

TECNOMECC s.r.l.  
Via Melara 11, 36041 Alte di Montebelluna, (VI) - Italy  
Tel. 0039 0444 694333 - Fax 0039 0444 698322  
info@pcb-tecnomecc.com - www.pcb-tecnomecc.com



MANUFACTURER OF PARTICLE ACCELERATORS  
AND VACUUM/PRESSURE VESSELS

[www.karlhugo.com](http://www.karlhugo.com)

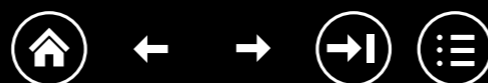



## Simulation enhances the understanding of solitons in fiber optics.

In the 1830s, John Scott Russell followed a wave on horseback along a canal. The wave seemed to travel forever. He came to call it “the wave of translation” and spent two years replicating it for further studies. Today, they are known as solitons and are relevant to fiber optics research. While Scott Russell had to build a 30-foot basin in his backyard, you can study solitons more easily using equation-based modeling and simulation.

The COMSOL Multiphysics® software is used for simulating designs, devices, and processes in all fields of engineering, manufacturing, and scientific research. See how you can apply it to soliton analysis for fiber optics.

[comsol.blog/chasing-waves](http://comsol.blog/chasing-waves)

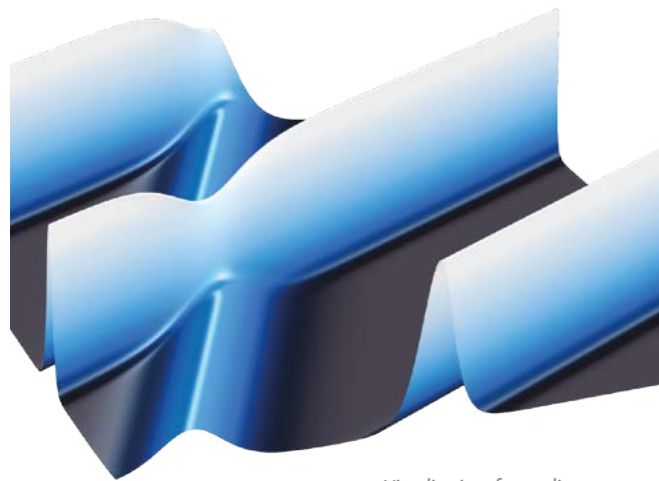

Visualization of two solitons colliding and reappearing in an optical fiber.

# THE FLAVOUR OF NEW PHYSICS



Recent experimental results hint that some electroweak processes are not lepton-flavour independent, contrary to Standard Model expectations. If the effect strengthens as more data are gathered, possible explanations range from new gauge forces to leptoquarks.

In 1971, at a Baskin-Robbins ice-cream store in Pasadena, California, Murray Gell-Mann and his student Harald Fritzsch came up with the term “flavour” to describe the different types of quarks. From the three types known at the time – up, down and strange – the list of quark flavours grew to six. A similar picture evolved for the leptons: the electron and the muon were joined by the unexpected discovery of the tau lepton at SLAC in 1975 and completed with the three corresponding neutrinos. These 12 elementary fermions are grouped into three generations of increasing mass.

The three flavours of charged leptons – electron, muon and tau – are the same in many respects. This “flavour universality” is deeply ingrained in the symmetry structure of the Standard Model (SM) and applies to both the electroweak and strong forces (though the latter is irrelevant for leptons). It directly follows from the assumption that the SM gauge group,  $SU(3) \times SU(2) \times U(1)$ , is one and the same for all three generations of fermions. The Higgs field, on the other hand, distinguishes between fermions of different flavours and endows them with different masses – sometimes strikingly so. In other words, the gauge forces, such as the electroweak force, are flavour-universal in the SM, while the exchange of a Higgs particle is not.

Experimental tests of whether or not the electroweak force is indeed flavour-universal directly check if our understanding of the subatomic world is correct, or if it

should be extended with new lepton non-universal forces. Such tests were discussed at the dawn of the flavour-physics programme in the early 1980s following the discovery of the b quark. Fast-forward almost 40 years, and we may be seeing the first deviations from lepton-flavour universality (LFU) for weak interactions, in measurements of b quarks bound inside B mesons.

Today, flavour physics is a major field of activity. A quick look at the Particle Data Group (PDG) booklet, with its long lists of the decays of B mesons, D mesons, kaons and other hadrons, gives an impression of the breadth and depth of the field. Even in the condensed version of the PDG booklet, such listings run to more than 170 pages. Still, the results can be summarised succinctly: all the measured decays agree with SM predictions, with the exception of measurements that probe LFU in two quark-level transitions:  $b \rightarrow c\tau\bar{\nu}_\tau$  and  $b \rightarrow s\mu^+\mu^-$ .

### Oddities in decays to D mesons

In the SM the  $b \rightarrow c\tau\bar{\nu}_\tau$  process is due to a tree-level exchange of a virtual W boson (figure 1, left). The W boson, being much heavier than the amount of energy that is released in the decay of the b quark, is virtual. Rather than materialising as a particle, it leaves its imprint as a very short-range potential that has the property of changing one quark (a b quark) into a different one (a c quark) with the simultaneous emission of a charged lepton and an antineutrino.

### THE AUTHORS

**Jorge Martin Camalich**  
*Instituto de Astrofísica de Canarias and Universidad de La Laguna, Spain*  
**Jure Zupan**  
*University of Cincinnati, USA.*

**FalconX8** POWERED BY SITORO ACCELERATED ANALYSIS

**The World's Most Advanced Digital Pulse Processor for high-rate Spectroscopy**



- Up to 8 channels of simultaneous processing
- Over 3 Mcps processed by each channel

sales@xia.com  
 Tel: +1-510-401-5760  
[www.xia.com](http://www.xia.com)

**XIA**  
 Instruments That Advance The Art

**Wide Band Current Monitor**



With a Pearson™ Current Monitor you can make precise amplitude and waveshape measurement of AC and pulse currents from milliamperes to kiloamperes. Current can be measured in any conductor or beam of charged particles, including those at very high voltages. A typical model gives you an amplitude accuracy of +1%, -0%, 20 nanosecond rise time, droop of 0.8% per millisecond, and a 3dB bandwidth of 1 Hz to 20 MHz. Other models feature 1.5 nanosecond rise time, or a droop as low as 0.05% per millisecond.

**Contact Pearson Electronics for application information.**

**Pearson Electronics**  
 4009 Transport St. Palo Alto, CA 94303 USA  
 Telephone: (650) 494-6444 FAX (650) 494-6716  
[www.pearsonelectronics.com](http://www.pearsonelectronics.com)

TMD

...the power in microwaves!



# ULTRA AVAILABLE AMPLIFIERS FOR ACCELERATOR & MEDICAL APPLICATIONS

TMD in collaboration with Rosatom - NIITFA is now able to offer revolutionary, ultra-available RF solid state amplifiers for scientific and medical applications.

Innovative power combining and control system results in:

- Ultra-compact systems, typically one 19" rack / 100 kW (pulse)
- CW / Pulse Systems, long pulse
- Modular Solid State architecture, compact modules (<10 kg)
- Highly Maintainable with **Hot Swap** capability
- Wall Plug efficiency competitive with tube technology (55% demonstrated)
- Highly robust to VSWR mismatch
- High MTBF and Low MTTR
- No loss of power from any single element failure
- High efficiency enhances reliability
- Frequencies available from 20 MHz to 1.3 GHz
- MW power capability

**Applications:**

- Synchrotrons, LINACs for scientific, experimentation/particle physics and Spallation systems
- Medical therapy equipment
- Cyclotrons for radioisotope production
- Option to upgrade existing systems

**Other Products:**

- High Power, Very Low Phase Noise TWT Amplifiers
- Brazed UHV components
- Electron Guns

For more information on our leading edge technology email us at [wecare@tmd.co.uk](mailto:wecare@tmd.co.uk) or visit [www.tmd.co.uk](http://www.tmd.co.uk)

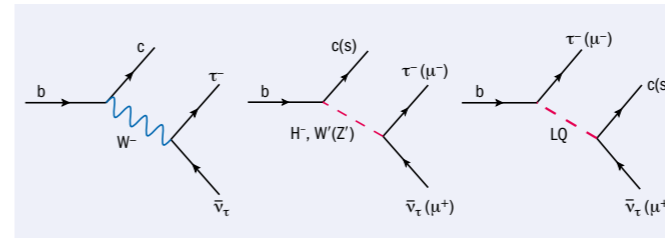

**Fig. 1.** The semileptonic decay of the b quark in the Standard Model (left). Possible new contributions to this process include exchanges of new colour-singlet states (middle), or new coloured states coupling simultaneously to quarks and leptons (right). The  $\bar{\nu}_\tau$  in  $b \rightarrow c\tau\bar{\nu}_\tau$  can also be replaced by a right-handed neutrino, which is not part of the Standard Model.

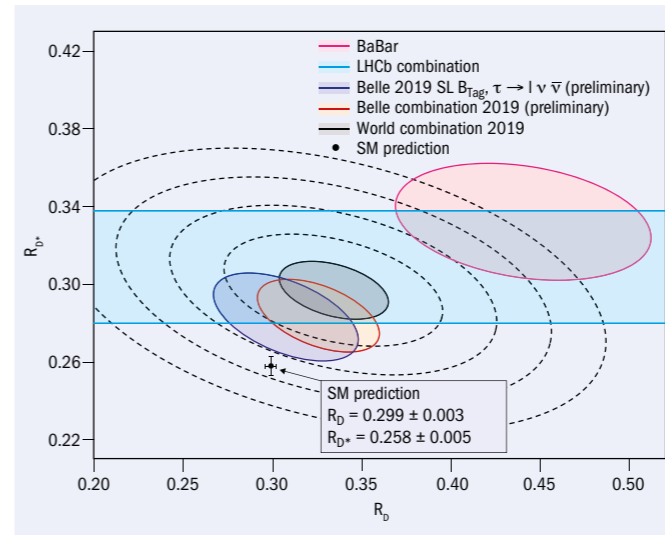

**Fig. 2.** Experimental results for the two observables probing lepton-flavour universality comparing  $b \rightarrow c\tau\bar{\nu}_\tau$  and  $b \rightarrow c\bar{l}\bar{\nu}_l$  decays,  $l=e, \mu$ . The point with error bars shows the SM prediction, while the shaded grey region shows the world experimental results average.

Flavour universality is probed by measuring the ratio of branching fractions:  $R_{D^{(*)}} = \text{Br}(B \rightarrow D^{(*)}\tau\bar{\nu}_\tau) / \text{Br}(B \rightarrow D^{(*)}l\bar{\nu}_l)$ , where  $l=e, \mu$ . Two ratios can be measured, since the charm quark is either bound inside a D meson or its excited version, the  $D^*$ , and the two ratios,  $R_D$  and  $R_{D^*}$ , have the very welcome property that they can be precisely predicted in the SM. Importantly, since the hadronic inputs that describe the  $b \rightarrow c$  transition do not depend on which lepton flavour is in the final state, the induced uncertainties mostly cancel in the ratios. Currently, the SM prediction is roughly three standard deviations away from the global average of results from the LHCb, BaBar and Belle experiments (figure 2).

A possible explanation for this discrepancy is that there is an additional contribution to the decay rate, due to the exchange of a new virtual particle. For coupling strengths that are of order unity, such that they are appreciably large yet small enough to keep our calculations reliable, the mass of such a new particle needs to be about 3 TeV to explain

**FEATURE LEPTON-FLAVOUR UNIVERSALITY**

the reported hints for the increased  $b \rightarrow c\tau\bar{\nu}_\tau$  rates. This is light enough that the new particle could even be produced directly at the LHC. Even better, the options for what this new particle could be are quite restricted.

There are two main possibilities. One is a colour singlet that does not feel the strong force, for which candidates include a new charged Higgs boson or a new vector boson commonly denoted  $W'$  (figure 1, middle). However, both of these options are essentially excluded by other measurements that do agree with the SM: the lifetime of the  $B_c$  meson; searches at the LHC for anomalous signals with tau leptons in the final state; decays of weak W and Z bosons into leptons; and by  $B_s$  mixing and  $B \rightarrow K\nu\bar{\nu}$  decays.

The second possible type of new particle is a leptoquark that couples to one quark and one lepton at each vertex (figure 3, right). Typically, the constraints from other measurements are less severe for leptoquarks than they are for new colour-singlet bosons, making them the preferred explanation for the  $b \rightarrow c\tau\bar{\nu}_\tau$  anomaly. For instance, they contribute to  $B_s$  mixing at the one-loop level, making the resulting effect smaller than the present uncertainties. Since leptoquarks are charged under the strong force, in the same way as quarks are, they can be copiously produced at the LHC via strong interactions. Searches for pair- or singly-produced leptoquarks at the future high-luminosity LHC and at a proposed high-energy LHC will cover most of the available parameter space of current models.

**Oddities in decays to kaons**

The other decay showing interesting flavour deviations ( $b \rightarrow s\mu^+\mu^-$ ) is probed via the ratios  $R_{K^{(*)}} = \text{Br}(B \rightarrow K^{(*)}\mu^+\mu^-) / \text{Br}(B \rightarrow K^{(*)}e^+e^-)$ , which test whether the rate for the  $b \rightarrow s\mu^+\mu^-$  quark-level transition equals the rate for the  $b \rightarrow se^+e^-$  one. The SM very precisely predicts  $R_{K^{(*)}} = 1$ , up to small corrections due to the very different masses of the muon and the electron. Measurements from LHCb on the other hand, are consistently below 1, with statistical significances of about 2.5 standard deviations, while less precise measurements from Belle are consistent with both LHCb and the SM (figure 3). Further support for these discrepancies is obtained from other observables, for which theoretical predictions are more uncertain. These include the branching ratios for decays induced by the  $b \rightarrow s\mu^+\mu^-$  quark-level transition, and the distributions of the final-state particles.

In contrast to the tree-level  $b \rightarrow c\tau\bar{\nu}_\tau$  process underlying the semileptonic B decays to D mesons, the  $b \rightarrow s\mu^+\mu^-$  decay is induced via quantum corrections at the one-loop level (figure 4, left) and is therefore highly suppressed in the SM. Potential new-physics contributions, on the other hand, can be exchanged either at tree level or also at one-loop level. This means that there is quite a lot of freedom in what kind of new physics could explain the  $b \rightarrow s\mu^+\mu^-$  anomaly. The possible tree-level mediators are a  $Z'$  and leptoquarks with masses of about 30 TeV or lighter, if the couplings are smaller. For loop-induced models the new particles are necessarily light, with masses in the TeV range or below. This means that the searches for direct production of new particles at the LHC can probe a significant range of explanations for the LHCb anomalies. However, for many of the possibilities the high-energy

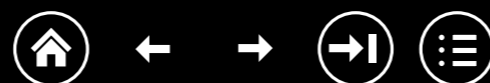

FEATURE LEPTON-FLAVOUR UNIVERSALITY

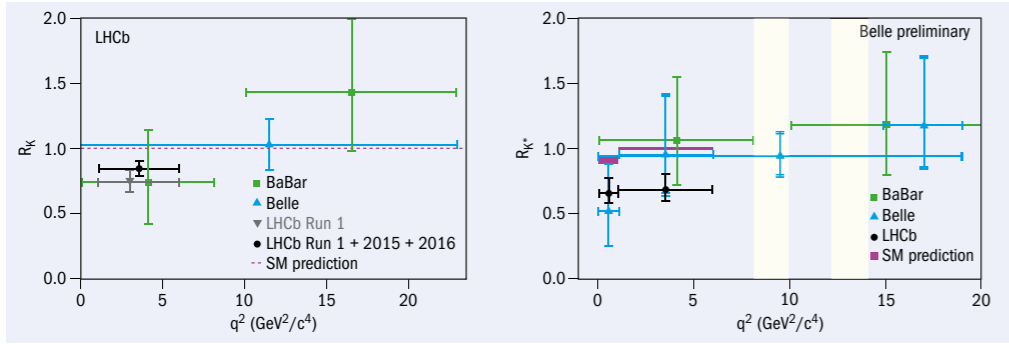

**Fig. 3.** The experimental results for  $R_{K^*}$ , measured in several bins of di-muon invariant mass squared,  $q^2$ . The vertical faint yellow bands denote resonance regions that are cut out in the analyses.

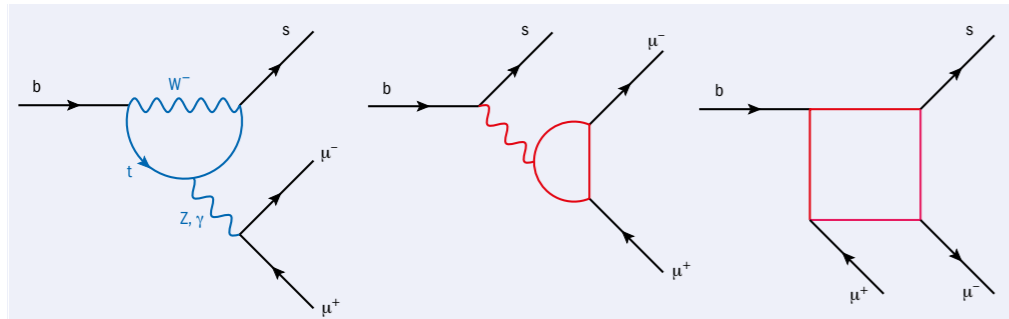

**Fig. 4.** Left: one of the Feynman diagrams giving the  $b \rightarrow s \mu^+ \mu^-$  transition in the SM. Middle and right: representative diagrams for models that generate  $b \rightarrow s \mu^+ \mu^-$  at one loop level, where the red lines correspond to particles beyond the SM.

upgrade to the LHC or a future circular collider with much higher energy would be required for the new particles to be discovered or ruled out.

**Taking stock**

Could the two anomalies be due to a single new lepton non-universal force? Interestingly, a leptoquark dubbed  $U_1$  – a spin-one particle that is a colour triplet, charged under hypercharge but not weak isospin – can explain both anomalies. With some effort it can be embedded in consistent theoretical constructions, albeit those with very non-trivial flavour structures. These models are based on modified versions of grand unified theories (GUTs) from the 1980s. Since GUTs unify the leptons and quarks, some of the force carriers can change quarks to leptons and vice versa, i.e. some of the force carriers are leptoquarks. The  $U_1$  leptoquark could be one such force carrier, coupling predominantly to the third generation of fermions. In all cases the  $U_1$  leptoquark is accompanied by many other particles with masses not much above the mass of  $U_1$ .

While intriguing, the two sets of B-physics anomalies are by no means confirmed. None of the measurements have separately reached the five standard deviations needed to claim a discovery and, indeed, most are hovering around the 1–3 sigma mark. However, taken together, they form an interesting and consistent picture that something is potentially going on. We are in a lucky position that new measurements are expected to be finished soon, some in a few months, others in a few years.

First of all, the observables showing the discrepancy from the SM,  $R_{D^{(*)}}$  and  $R_{K^{(*)}}$ , will be measured more precisely

at LHCb and at Belle II, which is currently ramping up at KEK in Japan. In addition, there are many related measurements that are planned, both at Belle II as well as at LHCb, and also at ATLAS and CMS. For instance, measuring the same transitions, but with different initial- and final-state hadrons, should give further insights into the structure of new-physics contributions. If the anomalies are confirmed, this would then set a clear target for the next collider such as the high-energy LHC or the proposed proton-proton Future Circular Collider, since the new particles cannot be arbitrarily heavy.

If this exciting scenario plays out, it would not be the first time that indirect searches foretold the existence of new physics at the next energy scale. Nuclear beta decay and other weak transitions prognosticated the electroweak W and Z gauge bosons, the rare kaon decay  $K_L \rightarrow \mu^+ \mu^-$  pointed to the existence of the charm quark, including the prediction for its mass from kaon mixing, while B-meson mixings and measurements of electroweak corrections accurately predicted the top-quark mass before it was discovered. Finally, the measurement of CP violation in kaons led to the prediction of the third generation of fermions. If the present flavour anomalies stand firm, they will become another important item on this historic list, offering a view of a new energy scale to explore. ●

**Further reading**

J Zupan 2019 arXiv:1903.05062.  
L Geng *et al.* 2017 *Phys. Rev. D* **96** 093006.  
D Buttazzo *et al.* 2017 *J. High Energy Phys.* **1711** 044.  
A Cerri *et al.* 2018 arXiv:1812.07638.

**While intriguing, the two sets of B-physics anomalies are by no means confirmed**



REALIZE THE FULL POTENTIAL OF PARTICLE THERAPY

With high precision comes high sensitivity. As the market leader in particle therapy treatment planning, RaySearch understands this. That's why we've designed RayStation® to account for every eventuality. RayStation makes it possible to create outstanding treatment plans for a large variety of particle therapy delivery techniques and beamlines. Experience the premier system, with access to all the unique innovations RayStation is renowned for.

**PROTON PLANNING**

- PBS, DS, US, LS, Wobbling
- Monte Carlo dose computation/optimization
- Robust optimization and evaluation
- PBS optimization with apertures/MLC
- Multi-criteria optimization, including robustness
- Fully integrated adaptive planning
- Simulated organ motion
- Interplay evaluation
- Automatic creation of backup photon plans

**CARBON-ION PLANNING\***

- Carbon-ion PBS optimization
- Robustness tools
- Multi-field and single-field optimization
- Plan directly deliverable on synchrotrons
- Combination planning with other modalities

**BORON NEUTRON CAPTURE THERAPY\***

- Support for defining BNCT-specific RBE models
- BNCT treatment plans creation

\*Subject to regulatory clearance in some markets.

ADVANCING CANCER TREATMENT

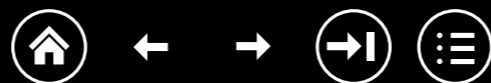

# THE PROTON LAID BARE

What a proton is depends on how you look at it, or rather on how hard you hit it.  
A century after Rutherford's discovery, our picture of this ubiquitous particle is coming into focus.

**THE AUTHOR**  
**Amanda Cooper-Sarkar**  
University of Oxford.

Every student of physics learns that the nucleus was discovered by firing alpha particles at atoms. The results of this famous experiment by Rutherford in 1911 indicated the existence of a hard-scattering core of positive charge, and, within a few years, led to his discovery of the proton (see p27). Decades later, similar experiments with electrons revealed point-like scattering centres inside the proton itself. Today we know these to be quarks, anti-quarks and gluons, but the glorious complexity of the proton is often swept under the carpet. Undergraduate physicists are more often introduced to quarks as objects with flavour quantum numbers that build up mesons and baryons in bound states of twos and threes. Indeed, in the 1960s, many people regarded quarks simply as a useful book-keeping device to classify the many new "elementary" particles that had been discovered in cosmic rays and bubble-chamber experiments. Few people were aware of the inelastic-scattering experiments at SLAC with 20 GeV electrons, which were beginning to reveal a much richer picture of the proton.

The results of these experiments in the 1960s and early 1970s were remarkable. Elastic scattering by the point-like electrons revealed the spatial distribution of the proton's charge, and cross sections had to be modified by form-factors as a result. These varied strongly depending on how hard the proton was struck – a hardness called the scale of the process,  $Q^2$ , defined by the negative squared four-momentum transfer between incoming and outgoing electrons. At high enough scales the proton broke up, a phenomenon that can be quantified by  $x$ , a kinematic variable related to the inelasticity of the interaction. Both the scale and the inelasticity could be determined from the dynamics of the outgoing electron. Physicists anticipated a complicated dependence on both variables. Studies of scattering at ever higher and lower scales continue to bear fruit to this day.

## A surprise at SLAC

The big surprise from the SLAC experiments was that the cross section did not depend strongly on  $Q^2$ , a phenomenon called "scaling". The only explanation for scaling was that the electrons were scattering from point-like centres within the proton. Feynman worked out the formalism to understand this by picturing the electron as hitting a point-like "parton" inside the proton. With elegant simplicity, he deduced that the partons each carried a fraction  $x$  of the proton's longitudinal momentum.

Gell-Mann and Zweig had proposed the existence of quarks in 1964, but at first it was by no means obvious that

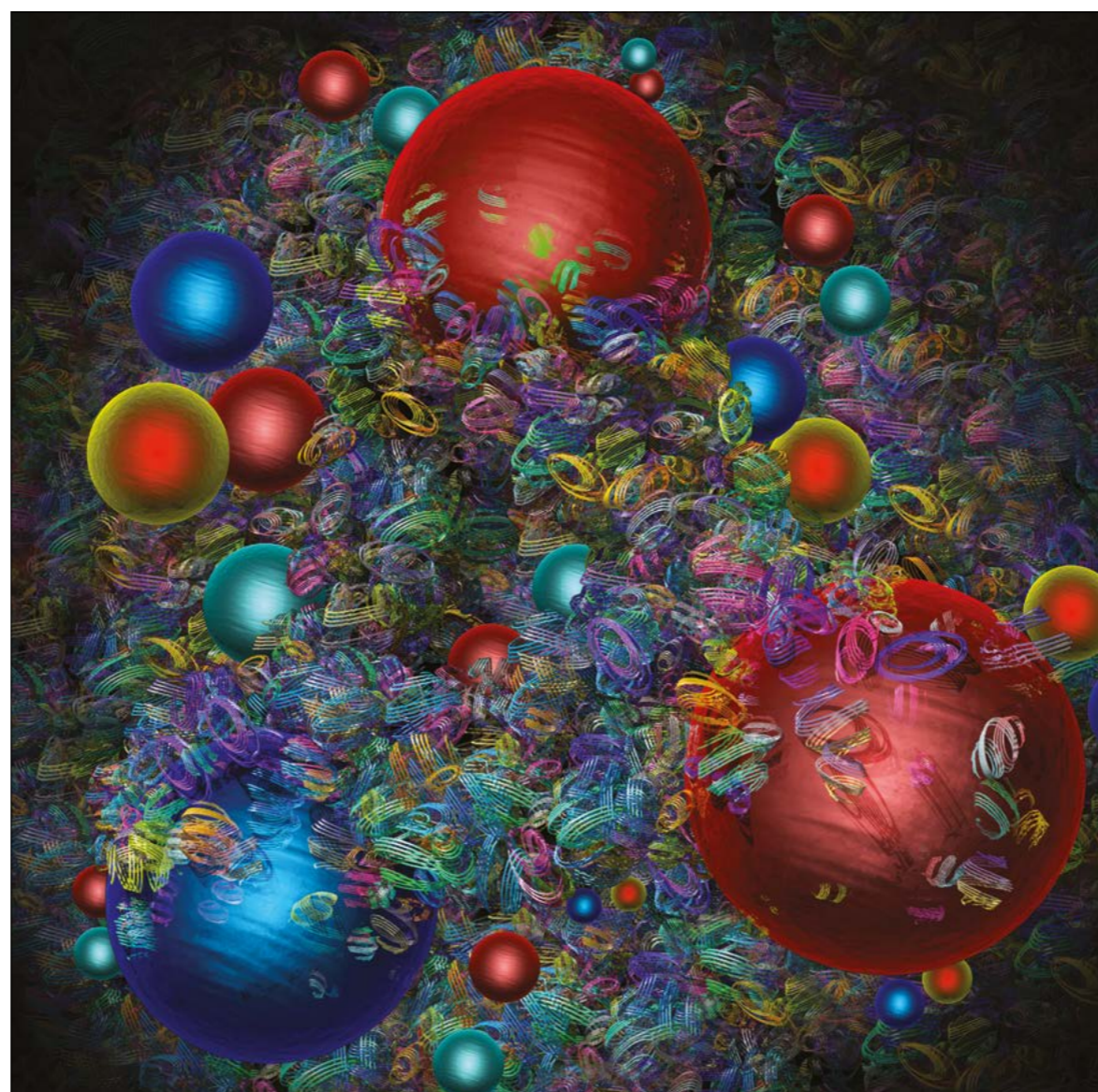

**Glorious complexity** An artist's impression of the mayhem of quarks and gluons inside the proton.

they were partons. The SLAC experiments established that the scattering centres had spin  $1/2$  as required by the quark model, but there were two problems. On the one hand there appeared to be not only three, but many scattering centres. On the other, Feynman's formalism required the partons to be "free" and independent of each other, yet they could hardly be independent if they remained confined in the proton.

## Painting a picture

The picture became even more interesting in the late 1970s and 1980s when scattering experiments started to use neutrinos and antineutrinos as probes. Since neutrinos and antineutrinos have a definite handedness, or helicity, such that their spin is aligned against their direction of motion for neutrinos and with it for antineutrinos, their weak interaction with quarks and antiquarks gives different angular distributions. This showed that there must be antiquarks as well as quarks within the proton. In fact, it led to a picture in which the flavour properties of the proton are governed by three valence quarks immersed in a sea of quark-antiquark pairs. But this is not all: the same experiments indicated that the total momentum carried by the valence quarks and the sea still amounts to only around half of that of the proton. This missing momentum was termed an energy crisis, and was solved by the existence of gluons with spin 1, which bind the quarks together and confine them inside the proton.

In fact, the SLAC experiments had been lucky to be making measurements in the kinematic region where scaling holds almost perfectly – where the cross section is independent of  $Q^2$ . The quark-parton model had to be extended, and became the field theory of quantum chromodynamics (QCD), in which the gluons are field carriers, just like photons in quantum electrodynamics (QED). Formulated in 1973, QCD has a much richer structure than QED. There are eight kinds of gluons that are characterised in terms of a new quantum number called colour, which is carried by both quarks and the gluons themselves, in contrast to QED, where the field carrier is uncharged. The gluon can thus interact with itself as well as with quarks.

From the 1980s onwards, a series of experiments probed increasingly deeply into the proton. Deep-inelastic-scattering experiments using neutrino and muon beams were performed at CERN and Fermilab, before the HERA electron-proton collider at DESY made definitive measurements from 1992 to 2007 (figure 1). The aim was to test the predictions of QCD as much as to investigate the structure of the proton,

**Experiments at CERN unearthed a mystery concerning the origin of the proton's spin**

**In the 1960s, many people regarded quarks simply as a useful book-keeping device**

FEATURE THE PROTON

FEATURE THE PROTON

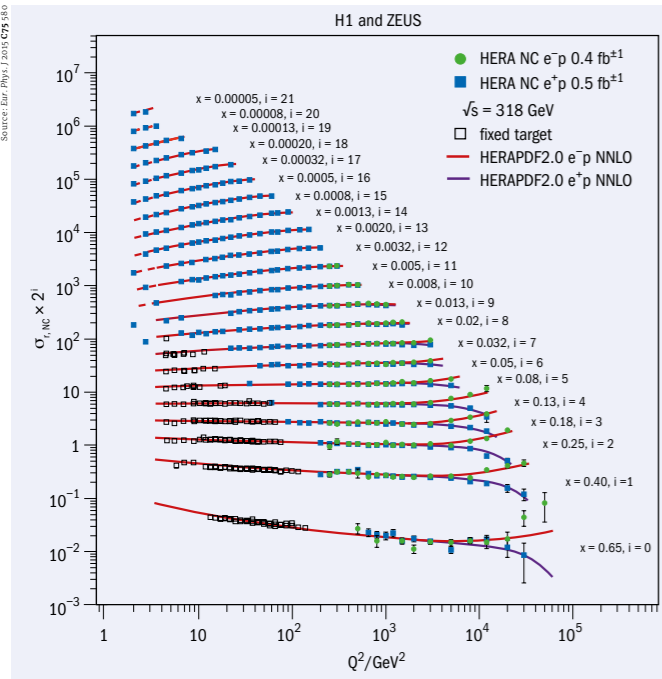

**Fig. 1.** HERA data on the  $e^+p$  scattering cross section is in close agreement with Standard Model predictions as a function of both scale,  $Q^2$ , and the interacting parton's momentum fraction,  $x$  (the factor  $z^2$  is artificially inserted to separate the curves vertically). At high  $x$  the cross section decreases with  $Q^2$  because the parton distribution functions (PDFs) decrease as the partons give up their momentum by radiating gluons that split to quark-antiquark pairs, which radiate again. Correspondingly, the low- $x$  PDFs increase.

The proton spin crisis

Among many misconceptions in the description of the proton presented in undergraduate physics lectures is the origin of the proton's spin. When we tell students about the three quarks in a proton, we usually say that its spin (equal to one half) comes from the arithmetic of three spin- $1/2$  quarks that align themselves such that two point "up" and one points "down". However, as shown in measurements of the spin taken by quarks in deep-inelastic-scattering experiments in which both the lepton beam and the proton target are polarised, this is not the case. Rather, as first revealed in results from the European Muon Collaboration in CERN's North Area in 1987, the quarks account for less than a third of the total proton spin. This was nicknamed the proton's "spin crisis", and attempts to fully resolve it remain the goal of experiments today. Physicists had to develop cleverer experiments, for example looking at semi-inclusive measurements of fast pions and kaons in the final state, and using polarised



**Illuminating** The 12 GeV CEBAF accelerator at Jefferson Lab may shed light on the source of the proton's missing spin.

proton-proton scattering, to determine where the missing spin comes from. It is now established that about 30% of the proton spin is in the valence quarks. Intriguingly, this is made up of +65% from up-valence and -35% from down-valence quarks. The sea seems to be unpolarised, and about 20% of the proton's spin is in gluon polarisation, though it is not possible to measure this accurately across a

wide kinematic range. Nevertheless, it seems unlikely that all of the missing spin is in gluons, and the puzzle is not yet solved. What could the origin of the remaining ~50% of the proton's spin be? The answer may lie in the orbital angular momentum of both the quarks and the gluons, but it is difficult to measure this directly. Orbital angular momentum is certainly connected to the transverse structure of the proton. The partons' transverse momentum must also be considered, and there is the transverse position of the partons, and the transverse, as opposed to longitudinal, spin. Multi-dimensional measurements of transverse momentum distributions and generalised parton distributions can give access to orbital angular momentum. Such measurements are underway at Jefferson Laboratory, and are also a core part of the future Electron-Ion Collider programme.

**Amanda Cooper-Sarkar** University of Oxford.

the goal being not just to list the constituents of the proton, but also to understand the forces between them. Meanwhile, the EMC experiment at CERN had unearthed a mystery concerning the origin of the proton's spin (see "The proton spin crisis"), while elsewhere, entirely different experiments were placing increasingly tough limits on the proton's lifetime (see "The pursuit of proton decay").

Quantum considerations

As with all quantum phenomena, what is in a proton depends on how you look at it. A more energetic probe has a smaller wavelength and therefore can reveal smaller structures, but it also injects energy into the system, and this allows the creation of new particles. The question then is whether we regard these particles as having been inside the proton in the first place. At higher scales quarks radiate gluons that then split into quark-antiquark pairs, which again radiate gluons: and the gluons themselves can also radiate gluons. The valence quarks thus lose momentum, distributing it between the sea quarks and gluons - increasingly many, with smaller and smaller amounts of momentum. A proton at rest is therefore very different to a proton, say, circulating in the Large Hadron Collider (LHC) at an energy of 7 TeV. The deep-inelastic-scattering data from muon, neutrino and electron collisions established that QCD was the correct theory of the strong interaction. Experiments found that the structure functions which describe the scattering cross sections are not completely independent of scale, but depend on it logarithmically - in exactly the way that QCD predicts. This allowed the determination of the strong coupling "constant"  $\alpha_s$ , in analogy with the fine structure constant of QED, and it is now understood that both parameters vary with the scale of the process. In contrast with QED, the

strong-coupling constant varies very quickly, from  $\alpha_s \sim 1$  at low energy to  $\sim 0.1$  at the energy scale of the mass of the Z boson. Thus the quarks become "asymptotically free" when examined at high energy, but are strongly confined at low energy - an insight leading to the award of the 2014 Nobel Prize in Physics to Gross, Politzer and Wilczek. Once QCD had emerged as the definitive theory, the focus turned to measuring the momentum distributions of the partons, dubbed parton distribution functions (PDFs, figure 2). Several groups work on these determinations using both deep-inelastic-scattering data and related scattering processes, and presently there is agreement between theory and experiment within a few percent across a very wide range of  $x$  and  $Q^2$  values. However, this is not quite good enough. Today, knowledge of PDFs is increasingly vital for discovery physics at the LHC. Predictions of all cross sections measured at the LHC - whether Standard Model or beyond - need to use input PDFs. After all, when we are colliding protons it is actually the partons inside the proton that are having hard collisions and the rates of these collisions can only be

predicted if we know the PDFs in the proton very accurately. The dominant uncertainty on the direct production of particles predicted by physics beyond the Standard Model now comes from the limited precision of the PDFs of high- $x$  gluons. Indirect searches for new physics are also affected: precision measurements of Standard Model parameters, such as the mass of the W-boson and the weak mixing angle  $\sin^2\theta_w$ , are also limited by the precision of PDFs in the regions where we currently have the best precision.

Strange sightings at the LHC

Standard Model processes at the LHC are now able to contribute to our knowledge of the proton. As well as reducing the uncertainty on PDFs, however, the LHC data have led to a surprise: there seem to be more strange quark-antiquark pairs in the proton than we had thought (CERN Courier April 2017 p11). A recent study of the potential of the High-Luminosity LHC suggests that we can improve the present uncertainty on the gluon PDF by more than a factor of two by studying jet production, direct photon production and

**Knowledge of PDFs is becoming increasingly vital for discovery physics at the LHC**

The pursuit of proton decay

When Rutherford discovered the proton in 1919, the only other basic constituent of matter that was known of was the electron. There was no way that the proton could decay without violating charge conservation. Ten years later, Hermann Weyl went further, proposing the first version of what would become a law for baryon conservation. Even after the discoveries of the positron, and positive muons and pions - all lighter than the proton - there was little reason to question the proton's stability. As Maurice Goldhaber famously pointed out, were the proton lifetime to be less than  $10^{16}$  years we should feel it in our bones, because our bodies would be lethally radioactive. In 1954 he improved on this estimate. Arguing that the disappearance of a nucleon would leave a nucleus in an excited state that could lead to fission, he used the observed absence of spontaneous fission in  $^{232}\text{Th}$  to calculate a lifetime for bound nucleons of  $> 10^{20}$  years, which Georgy Flerov soon extended to  $> 3 \times 10^{23}$  years.

Goldhaber also teamed up with Fred Reines and Clyde Cowan to test the possibility of directly observing proton decay using a 500 l tank of liquid scintillator surrounded by 90 photomultiplier tubes (PMTs) that was designed originally to detect reactor neutrinos. They found no signal, indicating that free protons must live for  $> 10^{21}$  years and bound nucleons for  $> 10^{22}$  years. By 1974, in a cosmic-ray experiment based on 20 tonnes of liquid scintillator, Reines and other colleagues had pushed the proton lifetime to  $> 10^{30}$  years. Meanwhile, in 1966, Andrei Sakharov

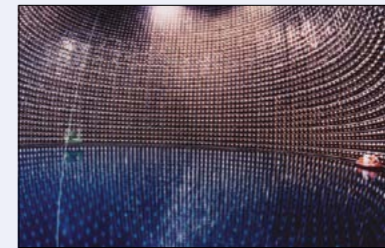

**Highlights** The Super-Kamiokande experiment in Japan has set the highest lower limit for proton decay.

had set out conditions that could yield the observed particle-antiparticle asymmetry of the universe. One of these was that baryon conservation is only approximate and could have been violated during the expansion phase of the early universe. The interactions that could violate baryon conservation would allow the proton to decay, but Sakharov's suggested proton lifetime of  $> 10^{30}$  years provided little encouragement for experimenters. This all changed around 1974, when proposals for grand unified theories (GUTs) came along. GUTs not only unified the strong, weak and electromagnetic forces, but also closely linked quarks and leptons, allowing for non-conservation of baryon number. In particular, the minimal SU(5) theory of Howard Georgi and Sheldon Glashow led to predicted lifetimes for the decay  $p \rightarrow e^+ \pi^0$  in the region of  $10^{31}$  years - not so far beyond the observed lower limit of around  $10^{30}$  years. This provided the justification for dedicated

proton-decay experiments. By 1981 seven such experiments installed deep underground were using either totally active water Cherenkov detectors or sampling calorimeters to monitor large numbers of protons. These included the Irvine-Michigan-Brookhaven (IMB) detector based on 3300 tonnes of water and 2048 5-inch PMTs and Kamiokande in Japan with 1000 tonnes of water and 1000 20-inch PMTs. These experiments were able to push the lower limits on the proton lifetime to  $> 10^{32}$  years and so discount the viability of minimal SU(5) GUTs. However, in 1987 IMB and Kamiokande II achieved greater fame by each detecting a handful of neutrinos from the supernova SN1987a. Kamiokande II was already studying solar and atmospheric neutrinos, but it was its successor, Super-Kamiokande, that went on to make pioneering observations of atmospheric and solar neutrino oscillations. And it is Super-Kamiokande that currently has the highest lower-limit for proton decay:  $1.6 \times 10^{34}$  years for the decay to  $e^+ \pi^0$ .

Today, the theoretical development of GUTs continues, with predictions in some models of proton lifetimes up to around  $10^{36}$  years. Future large neutrino experiments - such as DUNE, Hyper-Kamiokande and JUNO - feature proton decay among their goals, with the possibility of extending the limits on the proton lifetime to  $10^{35}$  years. So the study of proton stability goes on, continuing the symbiosis with neutrino research.

**Chris Sutton** former CERN Courier editor.

FEATURE THE PROTON

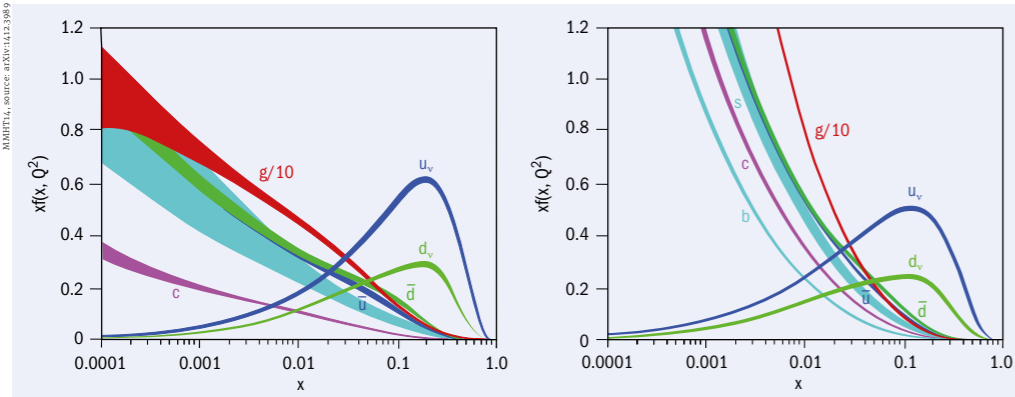

**Fig. 2.** The momentum distributions (PDFs) of all flavours of the partons at two scales ( $Q^2 = 10 \text{ GeV}^2$ , left, and  $10^4 \text{ GeV}^2$ , right). These curves are deduced from NNLO QCD fits to global hard-scattering data, with uncertainties arising from experimental errors and model assumptions.

Solving the proton-radius puzzle

How big is a proton? Experiments during the past decade have called well-established measurements of the proton's radius into question – even prompting somewhat outlandish suggestions that new physics might be at play. Soon-to-be-published results promise to settle the proton-radius puzzle once and for all.

Contrary to popular depictions, the proton does not have a hard physical boundary like a snooker ball. Its radius was traditionally deduced from its charge distribution via electron-scattering experiments. Scattering from a charge distribution is different from scattering from a point-like charge: the extended charge distribution modifies the differential cross section by a form factor (the Fourier transform of the charge distribution). For a proton this takes the form of a dipole with respect to the scale of the interaction, and an exponentially decaying charge distribution as a function of the distance from the centre of the proton. Scattering experiments found the root mean square (RMS) radius to be about 0.88 fm.

Since the turn of the millennium, a modest increase in precision on the proton radius was made possible by comparing measurements of transitions in hydrogen with quantum electrodynamics (QED) calculations. Since atomic energy levels need to be corrected due to overlapping electron clouds in the extended charge distribution of the proton, precise measurements of the transition frequencies provide a handle on the proton's radius. A combination of these measurements yielded the most recent CODATA value of 0.8751(61) fm.

The surprise came in 2010, when the CREMA collaboration at the Paul Scherrer Institute (PSI) in Switzerland achieved a 10-fold improvement in precision via the Lamb shift (the 2S-2P transition) in muonic hydrogen, the

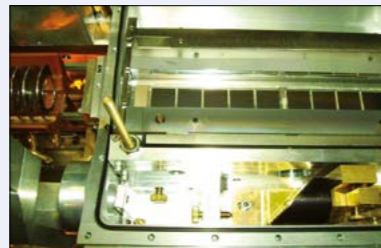

On target CREMA's target chamber.

bound state of a muon orbiting a proton. As the muon is 200 times heavier than the electron, its Bohr radius is 200 times smaller, and the QED correction due to overlapping electron clouds is more substantial. CREMA observed an RMS proton radius of 0.8418(7) fm, which was five sigma below the world average, giving rise to the so-called "proton radius puzzle". The team confirmed the measurement in 2013, reporting a radius of 0.8409(4) fm. These observations appeared to call into question the cherished principle of lepton universality.

More recent measurements have reinforced the proton's slimmed-down nature. In 2016 CREMA reported a radius of 0.8356(20) fm by measuring the Lamb shift in muonic deuterium (the bound state of a muon orbiting a proton and a neutron). Most interestingly, in 2017 Axel Beyer of the Max Planck Institute of Quantum Optics in Garching and collaborators reported a similarly lithe radius of 0.8335(95) fm from observations of the 2S-4P transition in ordinary hydrogen. This low value is confirmed by soon-to-be-published measurements of the 1S-3S transition by the same group, and of the 2S-2P transition by Eric Hessels of York University, Canada, and colleagues. "We can no longer speak about a discrepancy between measurements

of the proton radius in muonic and electronic spectroscopy," says Krzysztof Pachucki of CODATA TGFC and the University of Warsaw.

But what of the discrepancy between spectroscopic and scattering experiments? The calculation of the RMS proton radius using scattering data is tricky due to the proton's recoil, and analyses must extrapolate the form factor to a scale of  $Q^2 = 0$ . Model uncertainties can therefore be reduced by performing scattering experiments at increasingly low scales. Measurements may now be aligning with a lower value consistent with the latest results in electronic and muonic spectroscopy. In 2017 Miha Mihovilovic of the University of Mainz and colleagues reported an interestingly low value of 0.810(82) fm using the Mainz Microtron, and results due from the Proton Radius Experiment (pRad) at Jefferson Lab will access a similarly low scale with even smaller uncertainties. Preliminary pRad results presented in October 2018 at the 5th Joint Meeting of the APS Division of Nuclear Physics and the Physical Society of Japan in Hawaii indicate a proton radius of 0.830(20) fm. These electron-scattering results will be complemented by muon-scattering results from the COMPASS experiment at CERN, and the MUSE experiment at PSI.

For now, says Pachucki, the latest CODATA recommendations published in 2016 list the higher value obtained from electron scattering and pre-2015 hydrogen-spectroscopy experiments. If the latest experiments continue to line up with the slimmed-down radius of CREMA's 2010 result, however, the proton radius puzzle may soon be solved, and the world average revised downwards.

Mark Rayner CERN.

FEATURE THE PROTON

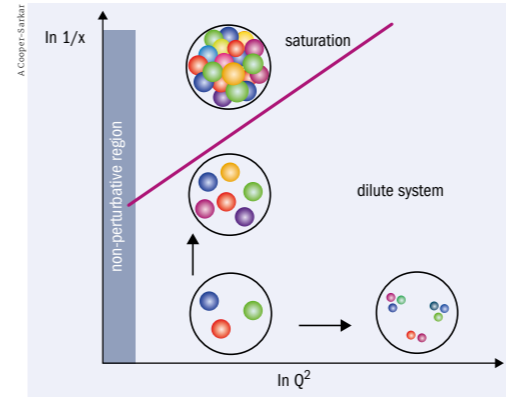

**Fig. 3.** The structure of the proton as a function of scale,  $Q^2$ , and fractional momentum,  $x$ . The number of partons increases with  $Q^2$ , but they have less momentum. The number of partons also increases as  $x$  decreases, to the point where the population is so dense that gluon recombination may lead to saturation. At low  $Q^2$  the strong coupling  $\alpha_s$  is so large that reliable perturbative calculations are not possible.

top quark-antiquark pair production. Measurements of the W-boson mass or the weak mixing angle will be improved by precision measurements of W and Z-boson production in previously unexplored kinematic regions, and strangeness can be further probed by measurements of these bosons in association with heavy quarks. We also look forward to possible future developments such as a Large Hadron-Electron Collider or a Future Circular Electron Hadron Collider – not least because new kinematic ranges continue to reveal more about the structure of QCD in the high-density regime.

In fact the HERA data already give hints that we may be entering a new phase of QCD at very low  $x$ , where the gluon density is very large (figure 3). Such large densities could lead to nonlinear effects in which gluons recombine. When the rate of recombination equals the rate of gluon splitting we may get gluon saturation. This state of matter has been described as a colour glass condensate (CGC) and has been further probed in heavy-ion experiments at the LHC and at RHIC at Brookhaven National Laboratory. The higher gluon densities involved in experiments with heavy nuclei enhance the impact of nonlinear gluon interactions. Interpretations of the data are consistent with the CGC but not definitive. A future electron-ion collider, such as that currently proposed in the US (CERN Courier October 2018, p31), will go further, enabling complete tomographic information about the proton and allowing us to directly connect fundamental partonic behaviour to the proton's "bulk" properties such as its mass, charge and spin. Meanwhile, table-top spectroscopy experiments are shedding new light on a seemingly mundane yet key property of the proton: its radius (see "Solving the proton-radius puzzle").

Together with the neutron, the proton constitutes practically all of the mass of the visible matter in the universe. A hundred years on from Rutherford's discovery, it is clear that much remains to be learnt about the structure of this complex and ubiquitous particle. ●

Further reading

R Devenish and A Cooper-Sarkar 2004 *Deep Inelastic Scattering* (Oxford University Press).  
J Campbell et al. 2018 *The Black Book of Quantum Chromodynamics* (Oxford University Press).

The HERA data already give hints of a new phase of QCD

Ultra High Performance Silicon Drift Detector

**FAST SDD®**

Count Rate = >1,000,000 CPS

The True State-of-the-Art

- New in-house manufacturing
- Lower noise
- Lower leakage current
- Better charge collection

Compatible with EPICS tools & libraries

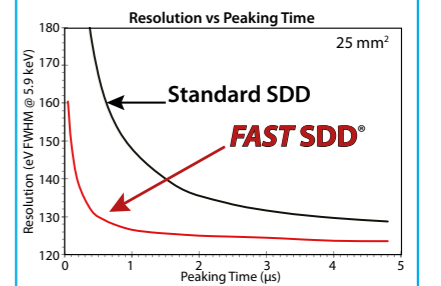
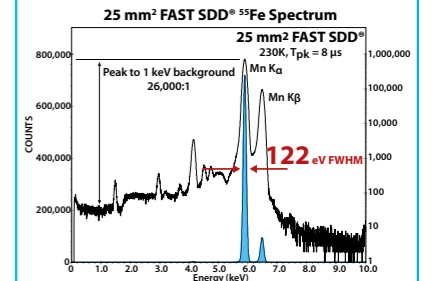

Options:

- 25 mm<sup>2</sup> active area collimated to 17 mm<sup>2</sup>
- 70 mm<sup>2</sup> collimated to 50 mm<sup>2</sup>
- Windows: Be (0.5 mil) 12.5 μm, or C Series (Si3N4)
- TO-8 package fits all Amptek configurations
- Vacuum applications



40 Years of Products for Your Imagination

**AMPTEK Inc.**  
sales@amptek.com  
www.amptek.com

**AMETEK**  
MATERIALS ANALYSIS DIVISION

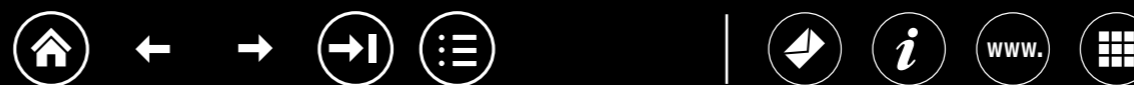

OUR CONTRIBUTION  
FOR YOUR DEMANDING APPLICATIONS



High-performance  
WELDED BELLOWS

Field-proven  
METAL SEALS

[www.vatvalve.com](http://www.vatvalve.com)

**We are in the loop**



**Flow Monitoring by ELETTA.**  
Extreme reliability on your  
cooling systems.  
Safety on critical applications.  
Supplier for more than  
40 years at CERN and other  
particle accelerators.

[www.eletta.com](http://www.eletta.com)  
[contact@eletta.fr](mailto:contact@eletta.fr)



YOUR PARTNER FOR PASSIVE RF COMPONENTS

TRANSMISSION LINES, COAXIAL & WAVEGUIDE

PATCH PANELS & SPLITTERS

CUSTOMISED RF COMPONENTS



[www.exirbroadcasting.com](http://www.exirbroadcasting.com)

Exir Broadcasting AB  
Industrigatan 17 - SE-242 31 Hörby - Sweden  
+46 415 30 14 00 - [info@exirbroadcasting.com](mailto:info@exirbroadcasting.com)

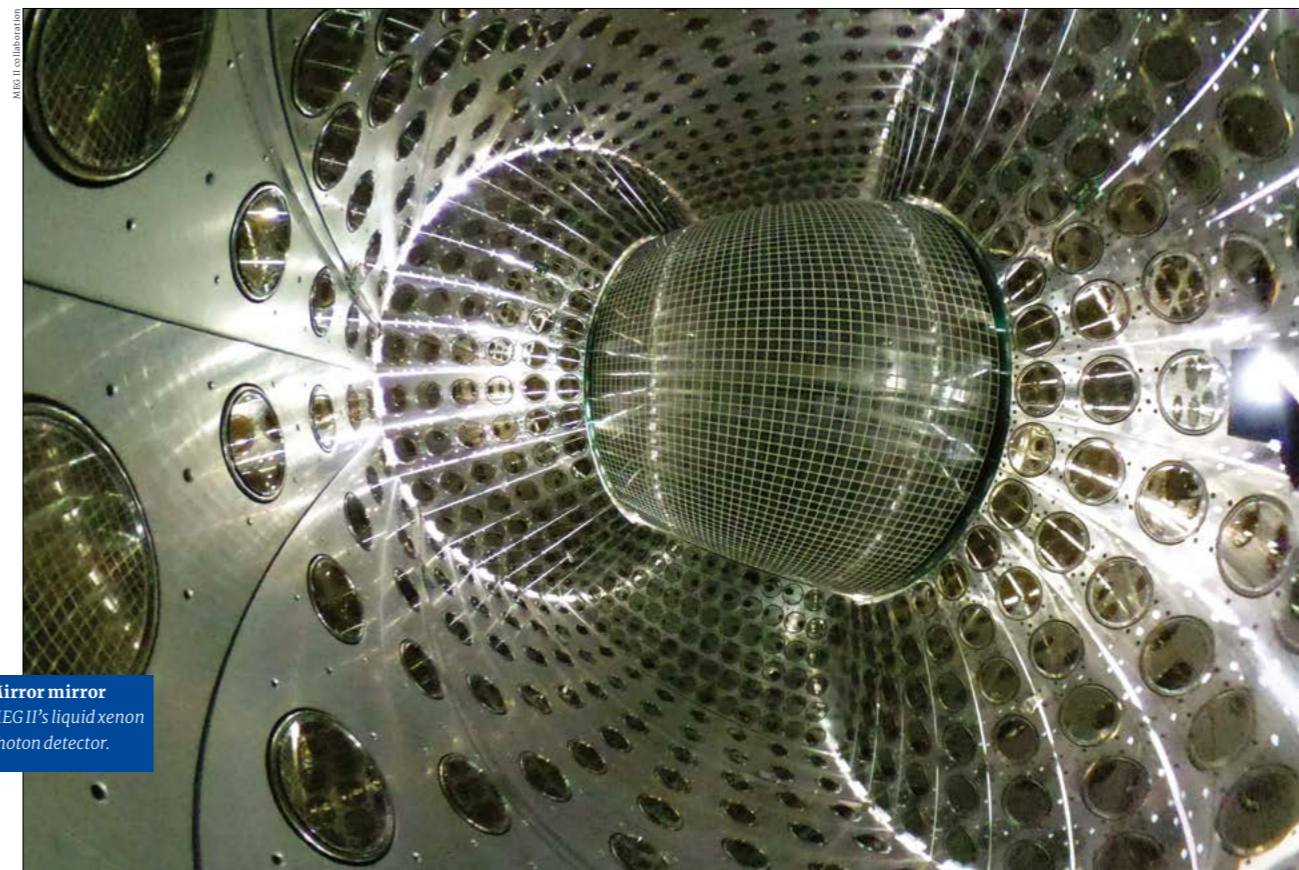

**Mirror mirror**  
MEG II's liquid xenon  
photon detector.

# HUNTING THE MUON'S FORBIDDEN DECAY

The MEG II experiment is preparing to probe the muon's flavour-violating decay to a positron and a photon with unprecedented sensitivity.

Searching for the decay  $\mu^+ \rightarrow e^+ \gamma$  is like looking for a needle in a haystack the size of the Great Pyramid of Giza. This simile-stretching endeavour is the task of the MEG II experiment at the Paul Scherrer Institute (PSI) in Villigen, Switzerland. MEG II is an upgrade of the previous MEG experiment, which operated from 2008 to 2013. All experimental data so far are consistent with muon decays that conserve lepton flavour by the production of two appropriately flavoured neutrinos. Were MEG II to observe the neutrinoless decay of the muon to a positron

and a photon, it would be the first evidence of flavour violation with charged leptons, and unambiguous evidence for new physics.

Lepton-flavour conservation is a mainstay of every introductory particle-physics course, yet it is merely a so-called accidental symmetry of the Standard Model (SM). Unlike gauge symmetries, it arises because only massless left-handed neutrinos are included in the model. The corresponding mass and interaction terms of the Lagrangian can therefore be simultaneously diagonalised, which means

**THE AUTHORS**

**Angela Papa**  
Paul Scherrer  
Institute,  
Switzerland,  
**Francesco Renga**  
INFN Rome, Italy  
and **Yusuke  
Uchiyama**  
The University of  
Tokyo, Japan.



FEATURE MEG II EXPERIMENT

FEATURE MEG II EXPERIMENT

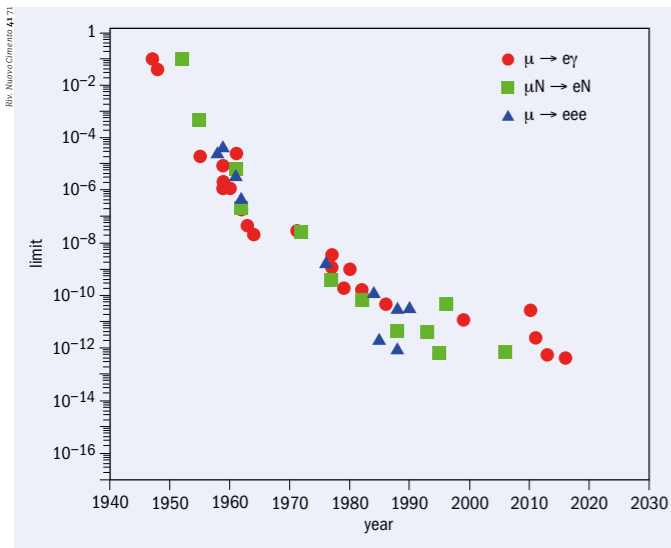

**Fig. 1.** Limits on the branching ratios of flavour-violating muon decays. In the mid 1950s, experiments using stopped pion beams improved on previous cosmic-ray limits, before experiments with stopped muons allowed further improvements in the mid 1970s. The current best limits in each channel were set by the MEG, SINDRUM-II and SINDRUM collaborations, respectively, each at PSI.

lepton-flavour violation in the SM<sup>3</sup> box). A data sample of muons as large as the number of protons in the Earth would not be enough to see such an improbable decay. Charged lepton-flavour violation is therefore a clear signature of new physics with no SM backgrounds.

**Finding the needle**

The search requires an intense source of muons, and detectors capable of reconstructing the kinematics of the muon's decay products with high precision. PSI offers the world's most intense continuous muon beams, delivering up to 10<sup>8</sup> muons per second. MEG II (previously as MEG) is designed to search for  $\mu^+ \rightarrow e^+ \gamma$  by stopping positive muons on a thin target, and looking for positron-photon pairs from muon decays at rest. This method exploits the two-body kinematics of the decay to discriminate signal events from the backgrounds, which are predominantly the radiative muon decay  $\mu^+ \rightarrow e^+ \nu_e \bar{\nu}_\mu \gamma$  and the accidental time coincidence of a positron and photon produced by different muon decays.

In the late 1990s, when the first MEG experiment was being designed, theorists argued that the  $\mu^+ \rightarrow e^+ \gamma$  branching ratio could be as high as 10<sup>-12</sup> to 10<sup>-14</sup>, based on supersymmetry arising at the TeV scale. Twenty years later, MEG has excluded branching ratios above 4.2 × 10<sup>-13</sup> (figure 1), and supersymmetric particles remain undiscovered at the LHC. Nevertheless, since charged lepton-flavour-violating processes are sensitive to the virtual exchange of new particles, while not requiring their creation as at the LHC, they can probe new physics models (supersymmetry, extra dimensions, leptoquarks, multi-Higgs, etc) up to mass scales of thousands of TeV. Scales such as these are not only unreachable at the LHC, but also at near-future accelerators.

The MEG collaboration therefore decided to upgrade the detectors with the goal of improving the sensitivity of the experiment by a factor of 10. The new experiment, which adopts the same measurement principle, is expected to start taking data at the end of 2019 (figure 2). Photons are reconstructed by a liquid xenon (LXe) detector technology that was pioneered by the MEG collaboration, achieving an

that interactions always conserve lepton flavour. This is not the case in the quark sector, and as a result quark flavour is not conserved in weak interactions. Since lepton flavour is not considered to be a fundamental symmetry, most extensions of the SM predict its violation at a level that could be observed by state-of-the-art experiments.

Indeed an extension of the SM is already required to include the tiny neutrino masses that we infer from neutrino oscillations. In this extension, neutrino oscillations induce charged lepton-flavour-violating processes but with the branching ratio for  $\mu^+ \rightarrow e^+ \gamma$  emerging to be only 10<sup>-54</sup>, which cannot be accessed experimentally (see "Charged

**Charged lepton-flavour violation in the SM – a very small neutrino oscillation experiment**

The presence of only massless left-handed neutrinos in the Standard Model (SM) gives rise to the accidental symmetry of lepton-flavour conservation – yet neutrino oscillation experiments have observed neutrinos changing flavour in-transit from sources as far away as the Sun and as near as a nuclear reactor. Such neutral lepton-flavour violation implies that neutrinos have tiny masses and that their flavour eigenstates are distinct from their mass eigenstates. Phases develop between the mass eigenstates

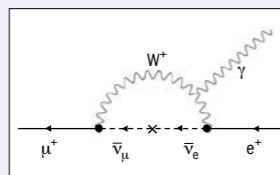

as a neutrino travels, and the wavefunction becomes a mixture of the flavour eigenstates, rather than the unique original flavour, as would remain the case for truly massless neutrinos. The effect on charged lepton-flavour violation is subtle

and small. In most neutrino oscillation experiments, a neutrino is created in a charged-current interaction and observed in a later interaction via the creation of a charged lepton of the corresponding flavour in the detector.  $\mu^+ \rightarrow e^+ \gamma$  may proceed in a similar way, but where the same W boson is involved in both the creation and destruction of the neutrino, and the neutrino oscillates in between (see figure above). In this process, the neutrino

oscillation  $\bar{\nu}_\mu \rightarrow \bar{\nu}_e$  has to occur at an energy scale  $E \sim m_w$ , over an extremely short distance of  $L \sim 1/m_w$ . Considering only two neutrino species with masses  $m_1$  and  $m_2$ , the probability for the oscillation is proportional to  $\sin^2[(m_1^2 - m_2^2)L/4E]$ . Hence, the  $\mu \rightarrow e \gamma$  branching ratio is suppressed by the tiny factor  $(m_1^2 - m_2^2)/m_w^2 \leq 10^{-49}$ . The exact calculation, including the most recent estimates of the neutrino mixing matrix elements, gives  $BR(\mu \rightarrow e \gamma) \sim 10^{-54}$ .

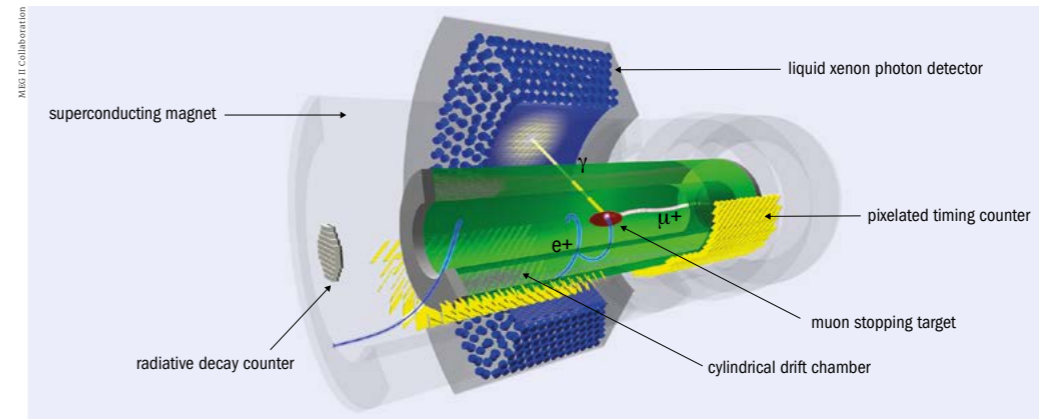

**Fig. 2.** Illustration of a  $\mu^+ \rightarrow e^+ \gamma$  event in MEG II.

unprecedented ~2% calorimetric resolution at energies as low as 52.8 MeV – the energy of the photon in a  $\mu^+ \rightarrow e^+ \gamma$  decay. The LXe detector provides a high-resolution measurement of the position and timing of the photon conversion, precise to a few millimetres and approximately 70 ps. The positrons are reconstructed in a magnetic spectrometer instrumented with drift chambers for tracking, and scintillator bars for timing. A peculiarity of the MEG spectrometer is a non-uniform magnetic field, diminishing from 1.2 T at the centre of the detector to 0.5 T at the extremities. The graded field prevents positrons from curling too many times. This avoids pileup in the detectors and makes positrons of the same momentum curl with the same radius, independent of their emission angle, thus simplifying the design and operation of the tracking system.

Following a major overhaul that was begun in 2011, all the detectors have now been upgraded. Silicon photomultipliers custom-modified for sensitivity to the ultra-violet LXe scintillation light have replaced conventional photomultipliers on the inner face of the calorimeter. Small scintillating tiles have replaced the scintillating bars of the positron-timing detector to improve timing and reduce pileup. The main challenge when upgrading the drift chambers was dealing with high positron rates. Here, the need for high granularity had to be balanced by keeping the total amount of material low. This reduces both multiple scattering and the rate of positrons annihilating in the material, and contributions to the coincident-photon background in the calorimeter. The solution was the use of extremely thin 40 and 50 μm silver-plated aluminium wires, 20 μm gold-plated tungsten wires, and innovative assembly techniques. All the detectors' resolutions were improved by a factor of around two with respect to the MEG experiment. The MEG II design also includes a new detector to veto photons coming from radiative muon decays, improved calibration tools and new trigger and data-acquisition electronics to cope with the increased number of readout channels. The improved detector performance will allow the muon beam rate to be more than doubled, from 3.3 × 10<sup>7</sup> to 7 × 10<sup>7</sup> muons per second.

The detectors were installed and tested in the muon beam in 2018. In 2019 a test of the whole detector will

be completed, with the possibility of collecting the first physics data. The experiment is then expected to run for three years to uncover evidence for the  $\mu^+ \rightarrow e^+ \gamma$  decay if the branching ratio is around 10<sup>-13</sup> or set a limit of 6 × 10<sup>-14</sup> on its branching ratio.

**New directions**

In the meantime, PSI researchers are investigating the possibility of building new beamlines with 10<sup>9</sup> or even 10<sup>10</sup> muons per second to allow experimenters to probe even smaller branching ratios. How could a future experiment cope with such high rates? Preliminary studies are investigating a system where photons are converted into pairs of electrons and positrons, and reconstructed in a tracking device. This solution, which has already been exploited previously by the MEGA experiment at Los Alamos National Laboratory, could also improve the photon resolution.

At the same time, other experiments are searching for charged lepton-flavour violation in other channels. Mu3e, also at PSI, will search for  $\mu^+ \rightarrow e^+ e^- e^-$  decays. The Mu2e and COMET experiments, at Fermilab and J-PARC, respectively, will search for muon-to-electron conversion in the field of a nucleus. These processes are complementary to  $\mu^+ \rightarrow e^+ \gamma$ , allowing alternative scenarios to be probed. At the same time, collider experiments such as Belle II and LHCb are working on studies of lepton-flavour violation in tau decays. LHCb researchers are also testing lepton universality, which holds that the weak couplings are the same for each lepton flavour (see p33). As theorists often stress, all these analyses are strongly complementary both with each other and with direct searches for new particles at the LHC.

Ever since the pioneering work of Conversi, Pancini and Piccioni, muons have played a crucial role in the development of particle physics. When I I Rabi exclaimed "who ordered that?", he surely did not imagine that 80 years later the lightest unstable elementary particle would still be a focus of cutting-edge research. ●

**Further reading**

- MEG Collaboration 2016 *Eur. Phys. J. C* **76** 434.
- MEG II Collaboration 2018 *Eur. Phys. J. C* **78** 380.
- L Calibbi and G Signorelli 2018 *Riv. Nuovo Cimento* **41** 71.

**Charged lepton-flavour-violating processes can probe new physics models up to mass scales of thousands of TeV**



# Cryogenic Components

- Cryogenic Control & Shut-off Valves
  - Quench Relief Valves & Current Leads
  - Single & Multi-Line Johnston Couplings
  - Check valves and associated products
- Focusing on cryogenic temperatures **below 100 K**
  - Optimized design for **low operating cost**
  - Suitable to operate in **high magnetic field** and **ionizing radiation**
  - **Long maintenance intervals** and **simple service requirements**
  - More than **40 years of experience**

Liquefaction of gases  
 Gas distribution systems  
 Gas recirculation systems  
 Hydrogen infrastructure  
 Space infrastructure  
 Plasma & fusion research



ARCA Flow Group worldwide:  
 Competence in valves, pumps & cryogenics



# OPINION VIEWPOINT

## Building scientific resilience

New political landscapes make international organisations in science more vital than ever, argues John Womersley.



**John Womersley** is director-general of the European Spallation Source.

Brest-Litovsk, Utrecht, Westphalia... at first sight, intergovernmental treaties belong more to the world of Bismarck and Napoleon than that of modern science. Yet, in March this year we celebrated the signing of a new treaty establishing the world's largest radio telescope, the Square Kilometre Array (SKA). Why use a tool of 19th-century great-power politics to organise a 21st century big-science project?

Large-science projects like SKA require multi-billion budgets and decades-long commitment. Their resources must come from many countries, and they need mutual assurance for all contributors that none will renege. The board for SKA, of which I was formerly chair, rapidly concluded that only an intergovernmental organisation could give the necessary stability. It is a very European approach, born of our need to bring together many smaller countries. But it is flexible and resilient.

Of course there are other ways to do this. A European Research Infrastructure Consortium (ERIC) is a lighter weight, faster way to set up an intergovernmental research organisation and is the model that we have used for the European Spallation Source (ESS) in Sweden. The ERIC is part of European Union (EU) legislation and provides many of the benefits in VAT and purchasing rules that an international convention or treaty would, without a convoluted approval process. Once the UK (one of the 13 ESS member nations) withdraws from the EU, it will need legislation to recognise the status of ERICs, just as non-EU Switzerland and Norway have done.

**CERN offers great stability in the face of political upheavals such as Brexit**

Research facilities can also be run by organisations without any intergovernmental authority: charities, not-for-profit companies or university consortia. This may seem quick and agile, but it is risky. For example, the large US telescope projects TMT and GMT are university-led and have been able to get started, but it seems that US federal involvement will



**Upwards** On 12 March SKA became the latest intergovernmental scientific organisation.

now be essential for their success.

In fact, US participation in international organisations is often an issue because it requires senate approval. The last time this happened for a science project was the ITER fusion experiment, which today is making good progress but had a rocky start. The EU is one of ITER's seven member entities and its involvement is facilitated via EUROfusion – one of eight European intergovernmental research organisations that are members of EIROforum. Most were established decades ago, and their stable structure has helped them invest in major new facilities such as ESO's European Extremely Large Telescope.

So international treaty-based science organisations are great for delivering big-science projects, while also promoting understanding between the science communities of different countries. In the aftermath of the Second World War that was really important, and was a founding motivation for CERN. More recently, the SESAME light source in Jordan adopted the CERN model to bring the Middle East's scientific communities together.

Today the world faces new political challenges, and international treaties don't do much to address the growing gap between angry, disenfranchised voters and an educated, internationally minded "elite". We scientists often see

nationalism as the problem, but the issue is more one of populism – and by being international we merely seem remote. We are used to speaking about outreach, but we also need to think seriously about "in-reach" within our own countries and regions, to engage better with groups such as Trump voters and Brexit supporters.

There's also the risk that too much stability can become rigidity. Organisations like SKA or ESS aim to provide room for negotiation and for substantial amounts of contributions to be made in-kind. They are free of commitments such as pension schemes and, in the case of SKA, membership levels are tied to the size of a country's astronomy community and not to GDP. Were a future, global project like a Future Circular Collider to be hosted at CERN, a purpose-built intergovernmental agreement would surely be the best way to manage it. CERN is the archetype of intergovernmental organisations in science, and offers great stability in the face of political upheavals such as Brexit. Its challenge today is to think outside the box.

The same applies to all big projects in physics today. Our future prosperity and ability to address major challenges depend on investments in large, cutting-edge research infrastructures. Intergovernmental organisations provide the framework for those investments to flourish.



### DLC, Boron Doped Hybrid and Graphene Stripper Foils

Applications include **beam strippers, accelerator targets, isotopic targets** etc  
**Increased flexibility** for easier handling  
**Superior physical properties** for longer lifetime

### Accelerator Targets

MICROMATTER™ manufactures custom made isotopic target for particle accelerators

### Thin Foils

MICROMATTER™ manufactures thin film foils for over 50 elements.

Micromatter Technologies Inc.  
 #1 8333 - 130 St.  
 Surrey, BC V3W 7X4 CANADA **+**  
 www.micromatter.com

Toll Free: (866) 966-2286  
 Ph: +1 (604) 594-9720  
 Fax: +1 (604) 594-9726  
 info@micromatter.com

Meet us at IPAC19



Full range of vacuum components



Custom manufacturing



Chambers and special projects



**www.vaqtec.com**  
 T. +39.011.0968307  
 Corso Grosseto 437 - 10151 Torino - Italy

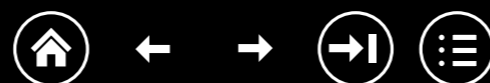



## Leading vacuum technology for new technologies



### Wideband Microwave Signal Generators

Standalone and programmable signal generators that fit in your hand. Portable, affordable, reliable.

Wideband 55 - 24,000MHz  
USB & Panel Control  
10Hz Frequency Step Size  
SCPI Automation Friendly  
Intuitive PC Software

Low Phase Noise  
Optional Ethernet Port  
Ultra-Precision Reference  
Stepped Power Control  
Vernier Power Control

Only \$1999<sup>00</sup>



### Mixers With Integrated Local Oscillators

2.5, 6.0, 12, and 20GHz Models  
Low Conversion Loss & Leakage  
Wide RF and IF Bandwidths  
Internal Reference Frequency  
Conveniently USB powered & Controlled

Starting at \$509<sup>00</sup>



### Wideband Programmable RF Step Attenuators

Up to 90dB of attenuation  
Exceptionally low insertion loss  
USB powered & controlled  
6, 12, and 18GHz frequency ranges  
Optional Ethernet Control

Starting at \$395<sup>00</sup>



DS INSTRUMENTS  
WWW.DSINSTRUMENTS.COM



## THE HERMETIC SEALING RANGE



MIL-C-26482  
feedthroughs  
and accessories



Sub-D peek connectors



Exclusive manufacturing  
Kapton & Peek  
insulated wires

www.hermetic-sealing.com

# OPINION INTERVIEW

## DESY's astroparticle aspirations

Christian Stegmann, director of DESY's newly established research division for astroparticle physics, describes the ambitious plans ahead in this vibrant field.

### What is your definition of astroparticle physics?

There is no general definition, but let me try nevertheless. Astroparticle physics addresses astrophysical questions through particle-physics experimental methods and, vice versa, questions from particle physics are addressed via astronomical methods. This approach has enabled many scientific breakthroughs and opened new windows to the universe in recent years. In Germany, what drives us is the question of the influence of neutrinos and high-energy processes in the development of our universe, and the direct search for dark matter. There are differences to particle physics both in the physics questions and in the approach: we observe high-energy radiation from our cosmos or rare events in underground laboratories. But there are also many similarities between the two fields of research that make a fruitful exchange possible.

### What was your path into the astroparticle field?

I grew up in particle physics: I did my PhD on b-physics at the OPAL experiment at CERN's LEP collider and then worked for a few years on the HERA-B experiment at DESY. I was not only fascinated by particle physics, but also by the international cooperation at CERN and DESY. Particle physics and astroparticle physics overcome borders, and this is a feat that is particularly important again today. Around 20 years ago I switched to ground-based gamma astronomy. I became fascinated in understanding how nature manages to accelerate particles to such enormous energies as we see them in cosmic rays and what role they play in the development of our universe. I experienced very closely how astroparticle physics has



Clear vision Christian Stegmann became director of astroparticle physics in January.

developed into an independent field. Seven years ago, I became head of the DESY site in Zeuthen near Berlin. My task is to develop DESY and in particular the Zeuthen site into an international centre for astroparticle physics. The new research division is also a recognition of the work of the people in Zeuthen and an important step for the future.

### What are DESY's strengths in astroparticle research?

Astroparticle physics began in Zeuthen with neutrino astronomy around 20 years ago. It has evolved from humble beginnings, from a small stake in the Lake Baikal experiment to a major role in the km<sup>3</sup>-sized IceCube array deep in the Antarctic ice. Having entered high-energy gamma-ray astronomy only a few years ago, the Zeuthen location is now a driving force behind the next-

**I was not only fascinated by particle physics, but also by the international cooperation at CERN and DESY**

generation gamma-ray observatory the Cherenkov Telescope Array (CTA). The campus in Zeuthen will host the CTA Science Data Management Centre and we are participating in almost all currently operating major gamma-ray experiments to prepare for the CTA science harvest. A growing theoretical group supports all experimental activities. The combination of high-energy neutrinos and gamma rays offers unique opportunities to study processes at energies far beyond those reachable by human-made particle accelerators.

### Why did DESY establish a dedicated division?

A dedicated research division underlines the importance of astroparticle physics in general and in DESY's scientific programme in particular, and offers promising opportunities for the future.



OPINION INTERVIEW

Astroparticle physics with cosmic messengers has experienced a tremendous development in recent years. The discovery of a large number of gamma-ray sources, the observation of cosmic neutrinos in 2013, the direct detection of gravitational waves in 2015, the observation of the merger of two neutron stars with more than 40 observatories worldwide triggered by its gravitational waves in August 2017, and the simultaneous observation of neutrinos and high-energy gamma radiation from the direction of a blazar the following month are just a few prominent examples. We are on the threshold of a golden age of multi-messenger astronomy, with gamma rays, neutrinos, gravitational waves and cosmic rays together promising completely new insights into the origins and evolution of our universe.



**Contact point** The winning design for DESY's new CTA Science Data Management Centre by Heinle Wischer und Partner (Berlin) and Ulrich Krüger Landschaftsarchitekten (Dresden).

**What are the division's scale and plans?**

The next few years will be exciting for us. We have just completed an architectural competition, new buildings will be built and the entire campus will be redesigned in the coming years. We expect well over 350 people to work on the Zeuthen campus, and hosting the CTA data centre will make us a contact point for astroparticle physicists globally. In addition to the growth through CTA, we are expanding our scientific portfolio to include radio detection of high-energy neutrinos and increased activities in astronomical-transient-event follow-up. We are also establishing close cooperation with other partners. Together with the Weizmann Institute in Israel, the University of Potsdam and the Humboldt University in Berlin, we are currently establishing an international doctoral school for multi-messenger astronomy funded by the Helmholtz Association.

**How can we realise the full potential of multi-messenger astronomy?**

Our potential lies primarily in committed scientists who use their creativity and ideas to take advantage of existing opportunities. For years we have experienced a large number of young people moving into astroparticle physics. We need new, highly sensitive instruments and there is a whole series of outstanding project proposals waiting to be implemented. CTA is being built, the upgrade of the Pierre Auger Observatory is

**We are on the threshold of a golden age of multi-messenger astronomy**

progressing and the first steps for the further upgrade of IceCube have been taken. The funding for the next generation of gravitational-wave experiments, the Einstein Telescope in Europe, is not yet secured. We are currently discussing a possible participation of DESY in gravitational-wave astronomy. Multi-messenger astronomy promises a breathtaking amount of new discoveries. However, the findings will only be possible if, in addition to the instruments, the data are also made available in a form that allows scientists to jointly analyse the information from the various instruments. DESY will play an important role in all these tasks – from the construction of instruments to the training of young scientists. But we will also be involved in the development of the research-data infrastructure required for multi-messenger astronomy.

**How would you describe the astroparticle physics landscape?**

The community in Europe is growing. Not only in terms of the number of scientists, but also the size and variety of experiments. In many areas, European astroparticle physics is in transition from medium-sized experiments to large research infrastructures. CTA is the outstanding example of this. The large number of new scientists and the ideas for new research infrastructures show the great appeal of astroparticle physics as a young and exciting field. The proposed Einstein Telescope will cross the threshold of projects requiring

investments of more than one billion Euros, requiring coordination at European and international level. With the Astroparticle Physics European Consortium (APPEC) we have taken a step towards improved coordination. DESY is one of the founding members of APPEC and I have been elected vice-chairman of the APPEC general assembly for the next two years. In this area, too, we can learn something from particle physics and are very pleased that CERN is an associate member of APPEC.

**What implication does the update of the European strategy for particle physics have for your field?**

European astroparticle physics provides a wide range of input to the European Strategy for particle physics, from concrete proposals for experiments to contributions from national committees for astroparticle physics. The contribution to the construction of the Einstein Telescope deserves special attention, and my personal wish is that CERN will coordinate the Einstein Telescope, as suggested in the contribution. With the LHC, CERN has again demonstrated in an outstanding way that it can successfully implement major research projects. With the first gravitational-wave events, we saw only the first flashes of a completely unknown part of our universe. The Einstein Telescope would revolutionise our new view of the world.

Interview by **Matthew Chalmers** editor.

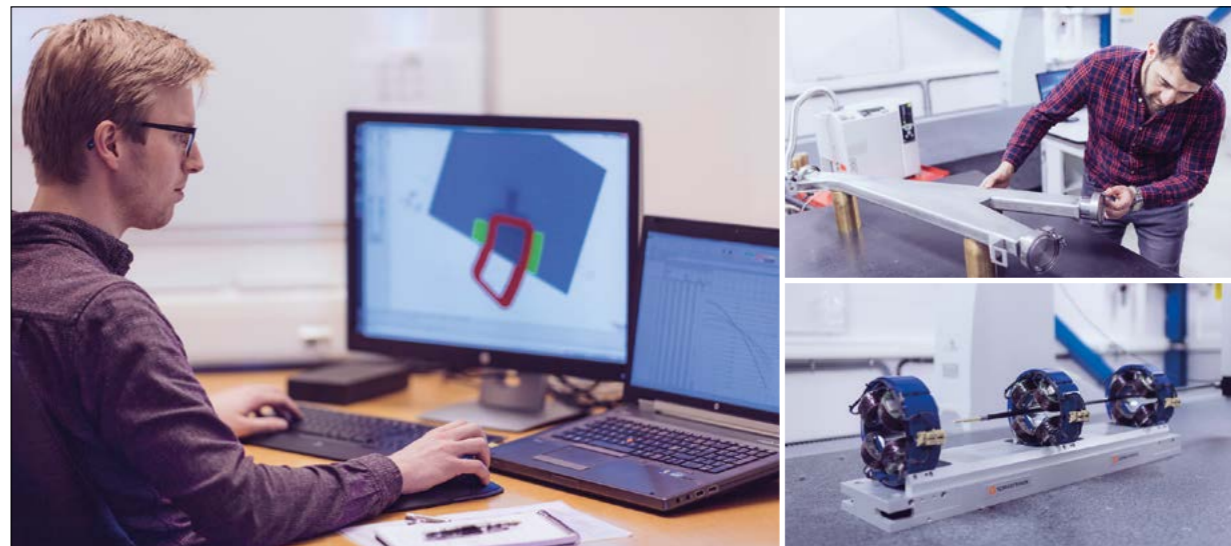

# Magnets and coils

High quality magnets and coils, designed and manufactured by Swedish engineering in order to provide the best solutions for all your needs! We take pride in close collaborations with the customer, whether it is for research or industry.

► [SCANDITRONIX-MAGNET.SE](http://SCANDITRONIX-MAGNET.SE)



## SUPERCON, Inc.

### Superconducting Wire and Cable

Standard and Specialty designs are available to meet your most demanding superconductor requirements.

SUPERCON, Inc. has been producing niobium-based superconducting wires and cables for half a century. We are the **original SUPERCON** – the world's first commercial producer of niobium-alloy based wire and cable for superconducting applications.

**Standard SC Wire Types**

- NbTi Wires
- Nb<sub>3</sub>Sn — Bronze
- Nb<sub>3</sub>Sn — Internal Tin
- CuNi resistive matrix wires
- Fine diameter SC Wires
- Aluminum clad wire
- Wire-in-Channel
- Innovative composite wires

**Product Applications**

- Magnetic Resonance Imaging
- Nuclear Magnetic Resonance
- High Energy Physics
- SC Magnetic Energy Storage
- Medical Therapeutic Devices
- Superconducting Magnets and Coils
- Crystal Growth Magnets
- Scientific Projects

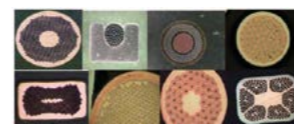

**"We deliver superconductivity!"**

Contact us at [sales@supercon-wire.com](mailto:sales@supercon-wire.com)  
[www.SUPERCON-WIRE.com](http://www.SUPERCON-WIRE.com)

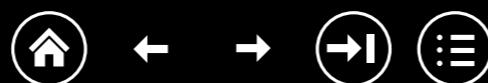

## Innovative & Reliable RF Power for the Science community

Communications & Power Industries: Powering scientific applications for over 75 years.

- Klystrons
- Inductive Output Tubes (IOTs)
- Power grid devices
- Gyrotrons
- Power Couplers
- Transmitters

Contact us for more information on our products and custom engineering designs.



## The new generation scintillator / Sipm detectors

- Compact
- Low power (5 V , 5 mA)
- Built-in temperature compensated bias generator / preamplifier
- PMT readout comparable energy resolution
- Wide choice of scintillator



SCIONIX Holland B.V.  
Tel. +31 30 6570312  
Fax. +31 30 6567563  
Email. [sales@scionix.nl](mailto:sales@scionix.nl)  
[www.scionix.nl](http://www.scionix.nl)

Contact us for more information



STAY CONNECTED  
RESTEZ CONNECTÉS

<http://alumni.cern>

 alumni

The High-Energy Network  
Le Réseau des hautes énergies

# OPINION REVIEWS

## Multi-messenger adventures

### Introduction to Particle and Astroparticle Physics: Multimessenger Astronomy and its Particle Physics Foundations (2nd edn)

By Alessandro De Angelis and Mário Pimenta

Springer

Recent years have seen enormous progress in astroparticle physics, with the detection of gravitational waves, very-high-energy neutrinos, combined neutrino-gamma observation and the discovery of a binary neutron-star merger, which was seen across the electromagnetic spectrum by some 70 observatories. These important advances opened a new and fascinating era for multi-messenger astronomy, which is the study of astronomical phenomena based on the coordinated observation and interpretation of disparate “messenger” signals.

This book, first published in 2015, is now released in a renewed version to include such recent discoveries and to describe present research lines.

The Standard Model (SM) of particle physics and the lambda-cold-dark-matter theory, also referred to as the SM of cosmology, have both proved to be tremendously successful. However, they leave a few important unsolved puzzles. One issue is that we are still missing a description of the main ingredients of the universe from an energy-budget perspective. This volume provides a clear and updated description of the field, preparing and possibly inspiring students towards a solution to these puzzles.

The book introduces particle physics

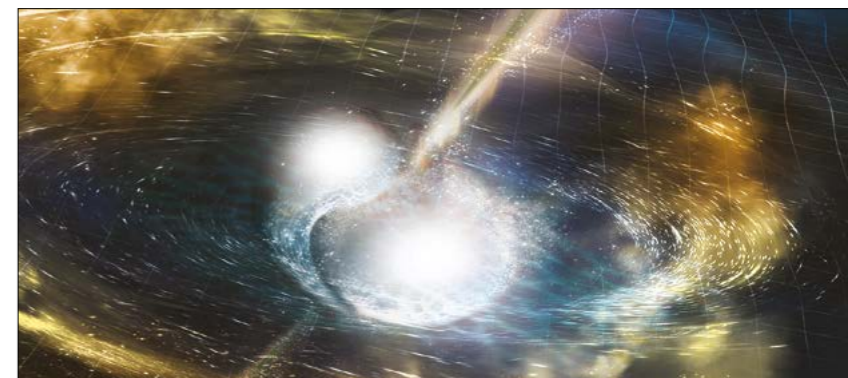

together with astrophysics and cosmology, starting from experiments and observations. Written by experimentalists actively working on astroparticle physics and with extensive experience in sub-nuclear physics, it provides a unified view of these fields, reflecting the very rapid advances that are being made.

The first eight chapters are devoted to the construction of the SM of particle physics, beginning from the Rutherford experiment up to the discovery of the Higgs particle and the study of its decay channels. The next chapter describes the SM of cosmology and the dark universe. Starting from the observational pillars of cosmology (the expansion of the universe, the cosmic microwave background and primordial nucleosynthesis), it moves on to a discussion about the origins and the future of our universe. Astrophysical evidence for dark matter is presented and its possible constituents and their detection are discussed. A separate chapter is devoted to neutrinos, covering natural and man-made sources; it presents the

**Mixed messages**  
Artist's impression of a neutron star merger producing gravitational waves, bursts of gamma rays and swirling clouds of ejected material.

state of the art and the future prospects in a detailed way. Next, the “messengers from the high-energy universe”, such as high-energy charged cosmic rays, gamma rays, neutrinos and gravitational waves, are explored. A final chapter is devoted to astrophysics and the relations between fundamental physics and life.

This book offers a well-balanced introduction to particle and astroparticle physics, requiring only a basic background of classical and quantum physics. It is certainly a valuable resource that can be used as a self-study book, a reference or a textbook. In the preface, the authors suggest how different parts of the essay can serve as introductory courses on particle physics and astrophysics, and for advanced classes of high-energy astroparticle physics. Its 700+ pages allow for a detailed and clear presentation of the material, contain many useful references and include proposed exercises.

Giovanni Fiorentini INFN and University of Ferrara.

### Rutherford

DVD documentary

Spacegirls Production Ltd

Professor Radium, the Atom Splitter, the Crocodile. Each is a nickname pointing to Ernest Rutherford, who made history by explaining radioactivity, discovering the proton and splitting the atom. All his



scientific and personal milestones are described in great detail in the three-part documentary *Rutherford*, produced by Spacegirls Production Ltd in 2011.

Accompanied by physics historian John Campbell, the viewer learns about this great scientist from his ordinary childhood as a “Kiwi boy” to his untimely death in 1937. Historical reconstructions and trips to the places (New Zealand, the

UK and Canada) that characterised his life bring Rutherford back to life.

When it was still heresy to think that there existed objects smaller than an atom, Rutherford was exploring the secrets of the invisible. During his first stay in Cambridge (UK), he discovered that uranium emits two types of radiation, which he named alpha and beta. Then, continuing his research at McGill Uni-



OPINION REVIEWS

versity (Canada), he discovered that radioactivity has to do with the instability of the atom. He was rewarded with the Nobel Prize in Chemistry in 1908, and called Professor Radium after a comic book character of that name. In those years, people did not know the effects of radiation and “radio-toothpaste” was available to buy. Then in Manchester (UK), he conducted the first artificial-induced nuclear reaction and described a new model of the atom, where a proton is like a fly in the middle of an empty cath-

dral. He fired alpha particles at nitrogen gas and obtained oxygen plus hydrogen, thus the epithet of the world’s first “atom splitter”.

In-between these big discoveries, the documentary points out that Rutherford blew tobacco smoke into his ionisation chamber, providing the groundwork for modern smoke detectors, proposed a more accurate dating system for the Earth’s age based on the rate of decay of uranium atoms, and campaigned for women’s opportunities and saving

scientists from war.

The name “Crocodile” came later, from soviet physicist Pyotr Kapitza, as it is an animal that never turns back – or perhaps a reference to Rutherford’s loud voice that preceded his visits. The carving of a crocodile on the outer wall of the Mond Laboratory at the Cavendish site, commissioned by Kapitza, still reminds Cambridge students and tourists of this outstanding physicist.

Letizia Diamante CERN.

Quàntica

Exhibition, Barcelona  
9 April – 24 September

Take a leap and enter, past the chalkboard wall filled with mathematical equations written, erased and written again, into the darkened room of projected questions where it all begins. What is reality? How do we describe nature? And for that matter, what is science and what is art?

Quàntica, which opened on 9 April at the Centre de Cultural Contemporània de Barcelona, invites you to explore quantum physics through the lens of both art and science. Curated by Mónica Bello, head of Arts at CERN, and art curator José-Carlos Mariategui, with particle physicist José Ignacio Latorre serving as its scientific adviser, Quàntica is the second iteration of an exhibition that brings together 10 artworks resulting from Collide International art residences at CERN.

The exhibition illustrates how interdisciplinary intersections can present scientific concepts regarded by the wider public as esoteric, in ways that bridge the gap, engage the senses and create meaning. Punctuating each piece is the idea that the principles of quantum physics, whether we like it or not, are pervasive in our lives today – from technological applications in smart phones and satellites to our philosophies and world views.

Nine key concepts – “scales”, “quantum states”, “overlap”, “intertwining”, “indeterminacy”, “randomness”, “open science”, “everyday quantum” and “change-evolution” – guide visitors through the meandering hallway. Each display point prompts pause to consider a question that underlies the fundamental principles of quantum physics. Juxtaposed in the shared space is an artist-made particle detector and parts of experiments displayed as artistic objects. Video art installations are interspersed with video interviews of CERN physicists, including Helga Timko, who asks: what if we were to teach children

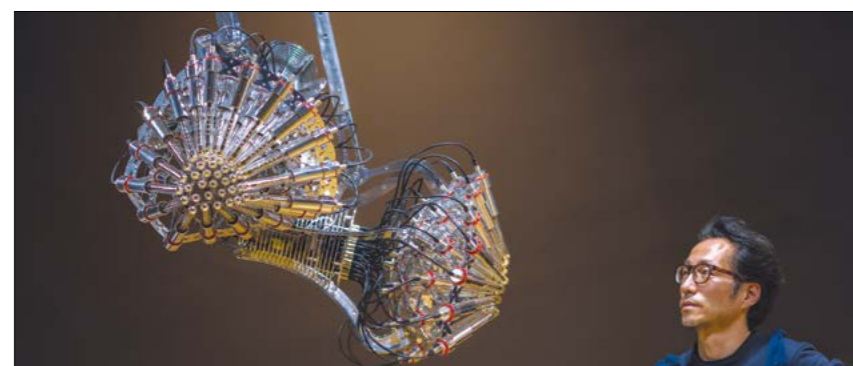

Knowledge sharing  
Yunchul Kim with his artwork Argos.

quantum physics at a very young age, would they perceive the world as we do? On the ceiling above is a projection of a spiral galaxy, a part of Juan Cortés’ *Supralunar*. Inspired by Vera Rubin’s work on dark matter and the rotational motion of galaxies, Cortés made a two-part multisensorial installation: a lens through which you see flashing lights and vibrating plates to rest your chin and experience, on some level, the intensity of a galaxy’s formation.

From the very large scale, move to the very small. A recording of Richard Feynman explaining the astonishing double-slit experiment plays next to a standing demonstration allowing you to observe the counterintuitive possibilities that exist at the subatomic level. You can put on goofy glasses for Lea Porsager’s *Cosmic Strike*, an artwork with a sense of humour, which offers an immersive 3D animation described as “hard science and loopy mysticism”. She engages the audience’s imagination to meditate on being a neutrino as it travels through the neutrino horn, one of the many scientific artefacts from CERN’s archives that pepper the path.

Around the corner is Erwin Schrödinger’s 1935 article where he first used the word “Verschränkung” (or entanglement) and Anton Zeilinger’s notes explaining the protocol for quantum

teleportation. Above these is projected a scene from *Star Trek*, which popularised the idea of teleportation.

The most visually striking piece in the exhibition is *Cascade* by Yunchul Kim, made up of three live elements. The first part is *Argos* (above), splayed metallic hands that hang like lamps from the ceiling – an operational muon detector made of 41 channels blinking light as it records the particles passing through the gallery. Each signal triggers the second element, *Impulse*, a chandelier-like fluid-transfer system that sends drops of liquid through microtubes that flow into transparent veins of the final element, *Tubular*. Kim, who won the 2016 Arts at CERN Collide International Award, is an artist who employs rigorous methods and experiments in his laboratory with liquid and materials. *Cascade* encapsulates the surprising results knowledge-sharing can yield.

Quàntica is a must-see for anyone who views art and science as opposite ends of the academic spectrum. The first version of the exhibition was held at Liverpool in the UK last year. Co-produced by the SCANNER network (CERN, FACT, CCCB, iMAL and Le Lieu Unique), the exhibition continues until 24 September in Barcelona, before travelling to Brussels.

Abha Eli Phoboo CERN.

MDC Europe's ISI division Offers a Complete Line of Electrical & Optical Ceramic-to-Metal Sealed Components

**ISI INSULATOR SEAL**  
a division of MDC Vacuum Products, LLC  
EUROPE

**ISO 9001:2015**

**BESPOKE MULTIPIN INSTRUMENTATION PLATE**  
for Particle Accelerator Research and Development

**APPLICATION**

- Data and Signal Collection from Vacuum System

**TECHNICAL SPECIFICATIONS**

- OD: 12"
- Helium Leak Rate: 2.0 X 10<sup>-10</sup> std.atm.cc/s
- Electrical Ratings:
  - 50 Pin Sub D: 500 V, 10 Amps
  - DE SVH-10: 10 kV, 5 Amps
  - DE COAX SMA: 700 V, 1 Amp

**MATERIAL SPECIFICATIONS**

- Flange: Stainless Steel
- Ceramic: 95% Min Alumina

Visit our new website!  
**ORDER ONLINE!**  
www.mdcvacuum.com

sales@mdcvacuum.co.uk  
+44 (0)1908 563267

in, twitter, facebook, instagram, pinterest, youtube

**Muons, Inc.**  
http://www.muonsinc.com/

**VISIT OUR BOOTH AT IPAC19**  
Hear more about our BHAG\*

Our BHAG: To make SRF accelerators so powerful and efficient that they can make enough neutrons to produce nuclear energy for electricity or process heat for less cost than from wind, solar, or natural gas, without nuclear weapon proliferation legacies of enrichment or chemical reprocessing, by burning unwanted nuclear materials.

\*BHAG: Big Hairy Audacious Goal, from “Built to Last: Successful Habits of Visionary Companies” by Jim Collins and Jerry Porras (2004)

**JANIS**

**Cryogen Free Probe Stations**

- Applications include nano science, materials and spintronics
- <5 K - 675 K cryocooler-based systems
- Vibration isolated for sub-micron sample stability
- Up to 8 probes, DC to 67 GHz, plus fiber optics
- Zoom optics with camera and monitor
- Horizontal, vertical or vector magnetic field options are available

Other configurations: LHe, LN<sub>2</sub>, room temperature and UHV systems

Contact us today:  
sales@janis.com  
www.janis.com/CryogenFreeProbeStation.aspx  
www.facebook.com/JanisResearch

# POWER SUPPLIES

for accelerator applications



High Voltage  
Power Supplies

Magnet  
Power Supplies

High Current  
Power Supplies

High Precision  
Power Supplies

As one of the market leaders for power supplies we set the benchmark in high precision and current. Heinzinger electronic offers a portfolio of excellent power supplies for research, industrial and medical accelerators.

- Voltages up to 300,000V in dry isolation
- High precision current regulation by DC/DC
- Current up to 10,000A
- Power up to 400,000W
- High accuracy, low ripple, high stability

Heinzinger electronic GmbH | 83026 Rosenheim - Germany  
Phone +49-8031-2458-0 | email: info@heinzinger.de | www.heinzinger.com



# PEOPLE CAREERS

## Science communication: a new frontier

Giovanni Mazzitelli describes the changing face of communication through the lens of European Researchers' Night.

In the world of communication, everyone has a role to play. During the past two decades, the ability of researchers to communicate their work to funding agencies, policymakers, entrepreneurs and the public at large has become an increasingly important part of their job. Scientists play a fundamental role in society, generally enjoying an authoritative status, and this makes us accountable.

Science communication is not just a way to share knowledge, it is also about educating new generations in the scientific approach and attracting young people to scientific careers. In addition, fundamental research drives the development of technology and innovation, playing an important role in providing solutions in challenging areas such as health care, the provision of food and safety. This obliges researchers to disseminate the results of their work.

### Evolving attitudes

Although science communication is becoming increasingly unavoidable, the skills it requires are not yet universal and some scientists are not prepared to do it. Of course there are risks involved. Communication can distract individuals from research and objectives, or, if done badly, can undermine the very messages that the scientist needs to convey. The European Researchers' Night is a highly successful annual event that was initiated in 2005 as a European Commission Marie



Nightlife A European Researchers' Night event in Frascati in 2018.

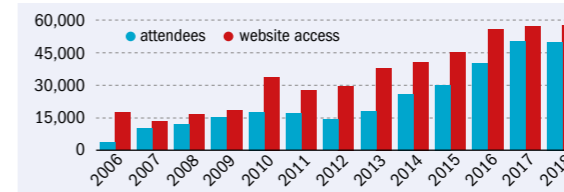

Fig. 1. Interest in Researchers' Night INFN-organised events has grown.

Skłodowska-Curie Action, and offers an opportunity for scientists to get more involved in science communication. It falls every final Friday of September, and illustrates how quickly attitudes are evolving.

In 2006, with a small group of researchers from the Italian National Institute for Nuclear Physics (INFN) located close to Frascati, we took part in one of the first Researchers' Night events. Frascati is surrounded by important scientific institutions and universities, and from the start the Italian National Agency for New Technologies, Energy and Sustainable Economic Development, the European Space Agency and the National Institute for Astrophysics joined the collaboration with INFN, along with the

Municipality of Frascati and the Cultural and Research Department of the Lazio region, which co-funded the initiative.

Since then, thousands of researchers, citizens, public and private institutions have worked together to change the public perception of science and of the infrastructure in the Frascati and Lazio regions, supported by the programme. Today, after 13 editions, it involves more than 60 scientific partners spread from the north to the south of Italy in 30 cities, and attracts more than 50,000 attendees, with significant media impact (figure 1). Moreover, it has now evolved to become a week-long event, is linked to many related events throughout the year,

and has triggered many institutions to develop their own science-communication projects.

Analysing the successive Frascati Researchers' Night projects allows a better understanding of the evolution of science-communication methodology. Back in 2006, scientists started to open their laboratories and research infrastructures to present their jobs in the most comprehensible way, with a view to increasing the scientific literacy of the public and to fill their "deficit" of knowledge. They then tried to create a direct dialogue by meeting people in public spaces such as squares and bars, discussing the more practical aspects of science, such as how public money is spent, and how much researchers are responsible for their work. Those were the years in which the socio-economic crisis started to unfold. It was also the beginning of the European Union's Horizon 2020 programme, when economic growth and terms such as "innovation" started to substitute scientific progress and discovery. It was therefore becoming more important than ever to engage with the public and keep the science flag flying.



ARMCO® Pure Iron

High Purity Iron for  
Magnetic Applications

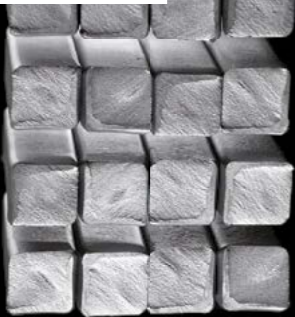

www.aksteel.eu



www.congratulationscern.com/  
it'sbeenagreat30years

At INSYTE Electronics we know the meaning of working for over 30 years to earn everyone's trust. 30 years that have meant a new age for humankind progress. By our Whole services, we like to think that we have contributed also to improve the World through our customers' Wished products. These past 30 years have been amazing and Insyte will keep on working to contribute to make the next 30 years to come even more stunning.

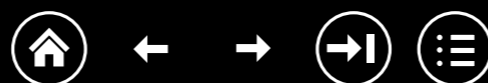

PEOPLE CAREERS

In recent years, this approach has changed. Two biannual projects that are also part of a Marie Skłodowska-Curie Action – Made in Science and BEES (BE a citizEn Scientist) underline a different vision of science and of the methodology of communication. Made in Science (which was live between 2016 and 2017) was supposed to rep-

resent the “trademark” of research, aiming to communicate to society the importance of the science production chain in terms of quality, identity, creativity, know-how and responsibility. In this chain, which starts from fundamental research and ends with social benefits, no one is excluded and must take part in the decision process and, where

possible, in the research itself. Its successor, BEES (2018–2019), on the other hand, aims to bring citizens up close to the discovery process, showing how long it takes and how it can be tough and frustrating. Both projects follow the most recent trends in science communication based on a participative or “public engagement” model, rather than

the traditional “deficit” model. Here, researchers are not the main actors but facilitators of the learning process with a specific role: the expert one.

**Nerd or not a nerd?**

Nevertheless, this evolution of science communication isn't all positive. There are many examples of problems in science communication: the explosion of concerns about science (vaccines, autism, GMO, homeopathy, etc); the avoidance of science and technology in preference to returning to a more “natural” life; the exploitation of science results (positive or negative) to support conspiracy theories or influence democracies; and overplaying the benefits for knowledge and technology transfer, to list a few examples. Last but not least, some strong bias still remains among both scientists and audiences, limiting the effectiveness of communication.

The first, and probably the hardest, is the stereotype bias: are you a “nerd”, or do you feel like a nerd? Often scientists refer to themselves as a category that can't be understood by society, consequently limiting their capacity to interact with the public. On the other hand, scientists are sometimes real nerds, and seen by the public as nerds. This is true for all job categories, but in the case of scientists this strongly conditions their ability to communicate.

Age, gender and technological bias also still play a fundamental role, especially in the most developed European countries. Young people may understand science and technology more easily, while women still do not seem to have full access to scientific careers and to the exploitation of technology. Although the transition from a deficit to a participative model is already common in education and democratic societies, it is not yet completed in science, which is likely because of the strong bias that still seems to exist among researchers and audiences. The Marie Skłodowska-Curie European Researchers' Night is a powerful way in which scientists can address such issues.

**Giovanni Mazzitelli** /INFN/  
Associazione Frascati Scienza.

PEOPLE CAREERS

Appointments and awards



**New leader at Perimeter Institute**  
Theorist Robert Myers has been appointed director of the Perimeter Institute for Theoretical Physics in Waterloo, Ontario, replacing Neil Turok, who has held the role since 2008. Myers is a leading researcher in the area of quantum fields and strings, and has received numerous awards. His research has primarily focused on gravitational aspects of string theory, most recently exploring applications of the AdS/CFT correspondence. “This is the opportunity of a lifetime,” said Myers after his appointment was made public.

**LIGO spokesperson elected**  
On 31 March, Patrick Brady of the University of Wisconsin-Milwaukee was elected spokesperson for the LIGO Scientific Collaboration, which is dedicated to the search for gravitational waves. Brady, who replaces former spokesperson David Shoemaker, takes the helm just as LIGO resumes observations following a series of upgrades that will increase the detector's sensitivity by about 40% compared to previous runs. Joining



LIGO is the European-based gravitational-wave detector Virgo in Italy, which has almost doubled its sensitivity since its last run.

**Abel prize for modern geometric analysis**

The Norwegian Academy of Science and Letters has awarded the 2019 Abel Prize to Karen



Uhlenbeck of the University of Texas at Austin “for her pioneering achievements in geometric partial differential equations, gauge theory and integrable systems, and for the fundamental impact of her work on analysis, geometry and mathematical physics”. It is the first time the prestigious prize has been awarded to a woman. Uhlenbeck is a founder of modern geometric analysis, and has made major contributions to gauge theory, having pioneered the study of Yang-Mills equations

from a rigorous analytical point of view.

**Inaugural philosophy award**

Adwait Parker is the inaugural winner of the new Du Châtelet Prize in Philosophy of Physics – created by Duke University and the journal *Studies in History and Philosophy of Science*. Parker, who has just completed his dissertation at Stanford University, won for his work: “Newton on active and passive quantities of matter”. The prize, named after philosopher Émilie Du Châtelet (1706–1749), recognises graduate students or recent PhDs for previously unpublished work in the philosophy of physics.



## PT2026 NMR Precision Teslameter

# Reach new heights in magnetic field measurement

The Metrolab PT2026 sets a new standard for precision magnetometers. Leveraging 30 years of expertise building the world's gold standard magnetometers, it takes magnetic field measurement to new heights: measuring higher fields with better resolution.

The PT2026 offers unprecedented flexibility in the choice of parameters, interfacing and probe placement, as well as greatly improved tolerance of inhomogeneous fields. And with Ethernet & USB interfaces and LabVIEW software, it fits perfectly into modern laboratory environments.

www.agence-arca.com - Photo: Scott Maxwell, Masterfile

**Metrolab**  
Magnetic precision has a name.

www.metrolab.com

## R&K 300kW All Solid-State RF Amplifier

### Model : CA500BW2-8085RP

R&K Company Limited R&K provides the world's most reliable high performance solid-state RF Power Amplifiers.

#### AMPLIFIER DESIGN

- Consists of four (4) rack-mounted 75kW SSAs.
- Able to deliver 300kW via 4-way power combiner.
- 96-way radial combiner for final power combining of 75kW SSA.
- Long-term & highly reliable operation achieved by protecting each final-stage transistor with built-in circulator at its output.

#### Output Power Linearity

#### Output Pulse

#### Pulse Rise

#### Pulse Fall

#### SPECIFICATION

- Frequency Range : 500MHz±1MHz
- Output Power : 320kW @Peak, 300kW (min.)  
\*Each rack-mounted amplifier section individually delivers 75kW. (75kW/rack ×4 outputs)
- Pulse Width : 1µs~300µs (max.)
- Duty : 0~3% (max.)
- Operation Mode : Class AB
- AC Supply Input : AC200V±10%/3φ, 50/60Hz
- Size : (W)2240mm×(D)1300mm×(H)1510mm

**R&K Company Limited**  
www.rk-microwave.com  
721-1 Maeda, Fuji-City, Shizuoka, 416-8577 Japan  
Tel:+81-545-31-2600 Fax:+81-545-31-1600 Email:info@rkco.jp

## Books on particle and nuclear physics

EDITOR'S PICK



### B Factories

Boštjan Golob

*B* factories are particle colliders at which specific subatomic particles – *B* mesons – are produced abundantly. The purpose is to study the properties of their decays in great detail in order to shed light on a mystery of eminently larger scale: why do we live in a universe composed of matter and no anti-matter? This book introduces readers to the physics laws of the CP asymmetry, touching on experimental requirements needed to perform such measurements at the subatomic level, and illustrating the main findings of the contemporary *B* factories.

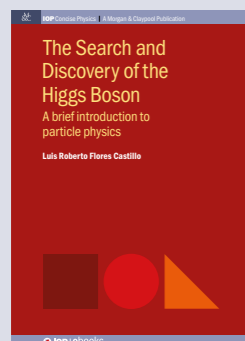

### The Search and Discovery of the Higgs Boson

A brief introduction to particle physics

Luis Roberto Flores Castillo

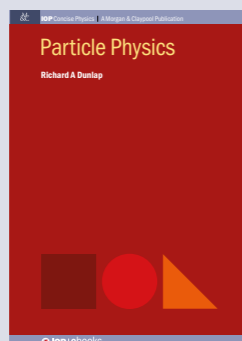

### Particle Physics

Richard A Dunlap

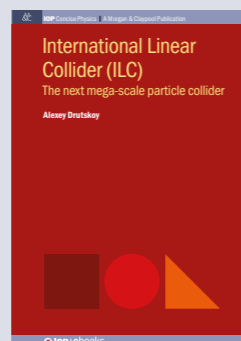

### International Linear Collider (ILC)

The next mega-scale particle collider

Alexey Drutskoy

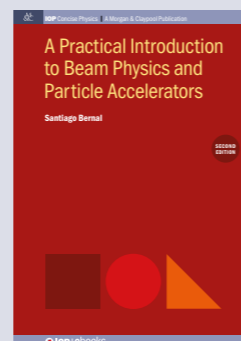

### A Practical Introduction to Beam Physics and Particle Accelerators

Second Edition

Santiago Bernal

We are actively commissioning in these fields, so if you have an idea for a book you'd like to discuss please contact [ebooks@ioppublishing.org](mailto:ebooks@ioppublishing.org). Visit [iopscience.org/books](http://iopscience.org/books) for more information and a full list of titles.

IOP Publishing | science first

# Advanced flexible cryostats

Cryoworld BV in Wieringerwerf is a manufacturer of cryogenic equipment. Our core business is design, production, testing and installation of Helium and other custom designed cryogenic equipment. Cryoworld specializes in the development of new cryogenic technologies and delivers projects to renowned companies and scientific institutes worldwide.

Cryoworld has developed two types of flexible cryostat with a length of 60 meters for CERN. One with passive thermal shielding and one with active thermal shielding. The cryostat will be used for superconducting cable in the superconducting (SC) link for the Hilumi upgrade project. Both cryostats are being tested and commissioned at CERN at the moment. Testing results are very positive. The heat leak values of this passive thermal shielded cryostat are at the same level as can be reached with ridged pipe and therefore are much better than any flexible cryostat has been able to perform in the past. This opens many possibilities for the application of flexible cryostats in any situation where long lengths and extremely low heat leak values are required for e.g. super conducting cables.

 advanced cryogenics

[www.cryoworld.com](http://www.cryoworld.com)

For further information please contact Cryoworld BV in the Netherlands: +31 (0) 228 74 39 30 | [info@cryoworld.com](mailto:info@cryoworld.com)



**IUVSTA  
EBARA  
AWARD**

**ARE YOU A YOUNG RESEARCHER WORKING IN THE AREA OF VACUUM SCIENCE AND TECHNOLOGY WITH A PASSION FOR ENVIRONMENT?**

Apply at [iuvsta.org](http://iuvsta.org)

Take the chance and participate in a contest for the development of environmentally friendly vacuum technologies. The winner will be awarded a prize to the amount of 3,000 euros at the IVC21 congress in Malmö/Sweden, July 1-5, 2019.



**Cool for Progress.**

BLUEFORS.COM

**Cooling Your Qubits.**

**BLUE FORS**



Scientific sessions | Industrial exhibition | Special focus workshops | Short courses



# 2019 IEEE Nuclear Science Symposium and Medical Imaging Conference

26th International Symposium on Room-Temperature X-Ray and Gamma-ray Detectors

Manchester Central Convention Centre  
26 October - 2 November, 2019  
Manchester, UK



A forum for physicists, engineers, mathematicians & computer scientists working on Radiation Detectors, Related Technologies and their applications

- ☐ Astrophysics: Synchrotron Radiation
- ☐ Nuclear and High Energy Physics
- ☐ Homeland Security
- ☐ Energy: Environmental Sciences
- ☐ Medical Imaging Systems
- ☐ Image Reconstruction & Data Analysis
- ☐ Radiation Therapy and Dosimetry

General Chair: Paul Marsden  
Deputy General Chair: Patrick Le Dû

**Scientific Program Chairs**

NSS: Cinzia Da Via and Yoshinobu Unno  
MIC: Dimitra Darambara and Suleman Surti  
RTSD: Paul Sellin and Michael Fiederle



[www.nss-mic.org/2019](http://www.nss-mic.org/2019) | [nssmic2019@ieee.org](mailto:nssmic2019@ieee.org)

**Abstract Submission Deadline 8 May 2019**

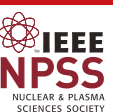

**CERN COURIER**

VOLUME 59 NUMBER 3 MAY/JUNE 2019

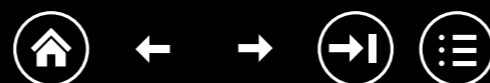

**IOP Publishing**



# RECRUITMENT

For advertising enquiries, contact *CERN Courier* recruitment/classified, IOP Publishing, Temple Circus, Temple Way, Bristol BS1 6HG, UK. Tel +44 (0)117 930 1264 E-mail [sales@cerncourier.com](mailto:sales@cerncourier.com). Please contact us for information about rates, colour options, publication dates and deadlines.

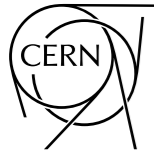

With 2600 staff members, 1800 other paid personnel and some 13 000 scientific users from almost 100 countries, the European Organization for Nuclear Research, CERN, an intergovernmental organisation with its seat at Geneva, Switzerland, is the leading international laboratory for fundamental research in particle physics. The annual Budget of some 1 billion Swiss francs is funded by its 23 Member and Associate Member States. CERN is presently operating the Large Hadron Collider (LHC), the world's most powerful particle accelerator that provides new insights into the origin and the structure of matter and into the forces governing the Universe.

The CERN Council is inviting applications for the appointment of a

## Director-General

for a five-year term starting on 1st January 2021.

Applicants are requested to address a letter of interest, with a detailed curriculum vitae, to the Chair of the Search Committee and send it to the CERN Council Secretariat before 31 May 2019. Full details of the position and application process can be consulted on: [careers.cern/DG](http://careers.cern/DG).

# Discover what's out there.

**brightrecruits**  
find your perfect job



Rat der Eidgenössischen Technischen Hochschulen  
ETH-Rat

Conseil des écoles polytechniques  
fédérales  
CEPF

Consiglio dei politecnici federali  
CPF

Board of the Swiss Federal Institutes of Technology  
ETH Board

The Paul Scherrer Institute (PSI) is the largest research institute for natural and engineering sciences within Switzerland and employs approximately 2,100 people. Its research focuses on three main subject areas: Matter and Materials, Energy and Environment, and Human Health. As a national user laboratory, PSI develops, constructs and operates complex large-scale research infrastructures. Every year, these unique facilities are used by more than 2,300 scientists from Switzerland and around the world. In addition to its research activities, PSI operates Switzerland's only proton therapy centre and works closely with the PARK INNOVAARE innovation park, one of the "Switzerland Innovation" sites.

PSI is part of the ETH Domain, which also includes ETH Zurich and EPFL as well as the federal research institutes WSL, Empa and Eawag. The ETH Board is the strategic management and supervisory body of the ETH Domain. The ETH Board is advertising the position of a male or female

### Director of the Paul Scherrer Institute (PSI)

in line with its mandate. The ETH Board is responsible for proposing a candidate for this position to the Swiss Federal Council. It is expected that the person appointed will hold a dual professorship at ETH Zurich and EPFL.

#### Requirements

You have an internationally recognised scientific track record in one of PSI's main subject areas, together with a thorough knowledge of the use, preferably also the planning, construction and operation, of large research facilities. As an experienced senior manager in a major organisation – ideally a large-scale international research infrastructure – or else in trade and industry, you have proven your integrative leadership skills. You have good networks inside and outside the scientific community and take an active role in scientific, technological and societal areas of current importance. Given your ability to establish strategic guidelines, you will commit yourself to developing PSI's future and helping to proactively shape the entire ETH Domain.

You are an open, creative and enthusiastic person, with integrity, a persuasive manner and the ability to make decisions quickly and effectively. Along with your excellent interpersonal skills, you demonstrate assertiveness and an ability to manage conflict. You possess very good communication skills, which you would use both inside and outside PSI, and you understand Switzerland's political structures, legislative processes and cultural diversity. Finally, you are interested in the wider economic and business context and have a good command of German and English, and preferably also a knowledge of French. You are willing to hold office for at least two terms of office (i.e. eight years). The successful candidate will be expected to take up this appointment at the start of 2020.

#### Applications

Please send your complete application to [Paulscherrer@egonzehnder.com](mailto:Paulscherrer@egonzehnder.com). Egon Zehnder is assisting the ETH Board in its preparations for the selection process. The interim President of the ETH Board, Beth Krasna, will be pleased to provide further information (phone +41 79 447 84 75, [beth.krasna@dethrat.ch](mailto:beth.krasna@dethrat.ch)). All applications received by 28 May 2019 will be considered in the selection process. Your data will be treated in strict confidence. It will be used only in connection with your application and in accordance with Swiss data protection law. By submitting your application, you give us your consent to process your data for this purpose and to exchange it with the above-mentioned company.

The ELI Project is an integral part of the European plan to build the next generation of large research facilities. ELI-Beamlines as a cutting edge laser facility is currently being commissioned near Prague, Czech Republic. ELI will be delivering ultra-short, ultra-intense laser pulses lasting typically a few tens of femtoseconds (10-100 fs) with peak power projected to reach 10 PW. It will make available multiple synchronized laser beams for sophisticated pump-probe experiments.

ELI (Extreme Light Infrastructure) project is involved in a European project Photon and Neutron Open Science Cloud – PaNOSC which aims at developing and providing services for scientific data and integrating them to the European Open Science Cloud (EOSC).

### Scientific Data Management Specialist (Software Engineer)

**Job description:** Your main mission will be to implement solutions for cataloging experimental data and metadata and integrating them into PaNOSC and EOSC. You will collaborate with multiple teams at ELI as well as within PaNOSC project to bring data from their acquisition to publicly accessible web services based on FAIR Data Principles (Findable, Accessible, Interoperable, Reusable).

**Required skills:** university degree in Computer Science, Engineering, Science, or related field • experience with working with scientific data and metadata • experience with setting up and managing databases • experience with development of APIs • experience with programming in Python • good knowledge of Linux/Unix programming environment • proficiency in English

**Desired skills:** experience with machine learning for big data processing • experience with control systems like TANGO • experience in European projects and international collaborations

### Scientific Data Analysis Specialist (Software Developer)

**Job description:** Your main mission will be to prototype, develop, and implement interactive web-based solutions for analysis of various scientific

datasets obtained from experiments at ELI facilities. You will collaborate with partners in the PaNOSC project on development and integration of these open-source tools and services into the EOSC.

**Required skills:** university degree in Computer Science, Engineering, Science, or related field • good knowledge of programming in Python, C++, C • experience with data analysis tools and techniques • experience with processing of scientific data • good knowledge of Linux/Unix programming environment • proficiency in English

**Desired skills:** experience with JupyterLab / Notebook • experience with Python libraries and tools for scientific computing: numpy, scipy, matplotlib, pandas, plotly, h5py • experience with machine learning (AI) solutions for big data processing and analysis • knowledge of remote data access and analysis workflows • experience with data visualization tools • knowledge of programming in C++, C • knowledge of web technologies: WebGL, javascript • experience with GPU technologies: CUDA, OpenGL, OpenCL, Vulkan • experience in European projects and international collaborations

**Job conditions:** the opportunity to participate in this unique scientific project • career growth, professional education • competitive and motivating salary • 5 weeks of holiday and other employee benefits

Applications, containing CV, cover letter, contacts of references, and any other material the candidate considers relevant, should be sent to Mrs. Jana Ženíšková, HR specialist ([jana.zeniskova@eli-beams.eu](mailto:jana.zeniskova@eli-beams.eu), +420 - 601560322).

Information regarding the personal data processing and access to the personal data at the Institute of Physics of the Czech Academy of Sciences can be found on: <https://www.fzu.cz/en/processing-of-personal-data>



## MAX-PLANCK-INSTITUT FÜR GRAVITATIONSPHYSIK (ALBERT-EINSTEIN-INSTITUT)

The Max Planck Institute for Gravitational Physics (Albert Einstein Institute) is a world-leading research institute specializing in gravitational physics. Around 400 international scientists work at the labs and offices located in Potsdam-Golm and Hannover, Germany.

We are seeking a

### Head of Administration (m/f/d)

The position is permanent and will be based in Potsdam-Golm.

The core departments of our administration are Finance, Human Resources and Purchasing. Our professional Administration Services Team provides high-quality support to our scientists and support staff. The working culture is collaborative, friendly and "can-do". Initiative is appreciated.

#### Duties and responsibilities

Leading a team of 15 professionals, you will be responsible for all administrative services at the Institute. Moreover, you will directly support the Board of Directors and Managing Director with their strategic decision making, executing their decisions when needed. A well-run administration is extremely important to support the scientific productivity of our Institute; therefore you will oversee business process improvement and the development of administration staff professional skills. Other aspects of the job include financial oversight for the whole Institute, managing communication with the Max Planck Society central administration, working collaboratively with other institutes (including two other Max Planck Institutes on the Potsdam-Golm Campus), project management, streamlining internal communication, and consulting specialists as appropriate (e.g. legal, tax, building services) to ensure compliance with legal, funding and Max Planck regulations.

#### Essential requirements

- Higher degree (Masters and preferably a PhD) or equivalent
- Relevant work experience, particularly in a leadership position in an academic and/or research environment
- Broad knowledge of administrative, employment, procurement and funding law
- Excellent leadership, people management and coaching skills
- Excellent project management and planning skills
- Excellent communication and interpersonal skills
- Excellent negotiation and influencing skills
- Excellent analytical and problem-solving skills
- Fluent colloquial and professional level German language, in both oral and written forms
- Fluent colloquial and professional level English language, in both oral and written forms
- Very good working ability with IT office software and ERP systems

#### Salary and Contract

The salary and contract will be based on previous experience according to TVöD guidelines (German collective wage agreement for the public service) up to EG 15 (Entgeltgruppe 15). This is a full-time permanent position. Working hours can be adjusted in accordance with family duties and needs.

#### Further Information

The Max Planck Institute for Gravitational Physics is an equal opportunity employer, and is committed to providing employment opportunities to all qualified applicants without regard to race, color, religion, age, sex, sexual orientation, gender identity, national origin, or disability.

The Max Planck Society is committed to increasing the number of individuals with disabilities in its workforce and therefore encourages applications from such qualified individuals.

Further information can be obtained from the current acting Head of Administration (vw-leiter@aei.mpg.de) or verwaltung@aei.mpg.de.

#### How to Apply

Please apply by sending the following to verwaltung@aei.mpg.de before 15<sup>th</sup> May 2019:

- Your curriculum vitae with your contact details included.
- Your education and work certificates.
- A cover letter
  - describing how you meet the criteria for this job.
  - giving examples of relevant projects/work you have done before, why you did them and what the benefits were.
  - identifying at least three people we can contact for reference.

Further information about data privacy at: [www.aei.mpg.de/1822816/PrivacyPolicy](http://www.aei.mpg.de/1822816/PrivacyPolicy)

Interviews will likely happen in June 2019.

Max-Planck-Institute for Gravitational Physics  
Am Muehlenberg 1 • 14476 Potsdam-Golm  
[www.aei.mpg.de](http://www.aei.mpg.de)



Universität Hamburg  
DER FORSCHUNG | DER LEHRE | DER BILDUNG

CLUSTER OF EXCELLENCE  
QUANTUM UNIVERSE



Quantum Universe is a newly established Cluster of Excellence as part of Germany's Excellence Strategy. It brings together leading scientists from mathematics, particle physics, astrophysics, and cosmology at Universität Hamburg and DESY to understand mass and gravity at the interface between quantum physics and cosmology.

We invite applications for

#### MORE THAN 30 PHD AND POSTDOC POSITIONS

on research topics of the Cluster of Excellence:

Higgs Physics • Dark Matter • Gravitational Waves • Quantum Theories and Mathematical Physics

Quantum Universe is looking for outstanding doctoral and postdoctoral researchers with excellent degrees and scientific track record.

Successful candidates will join an inspiring world-class environment for research and education and will be promoted through the Quantum Universe Research School.

For detailed information on the available positions and the application process please visit [www.qu.uni-hamburg.de/jobs.html](http://www.qu.uni-hamburg.de/jobs.html) or contact Dr. Michael Greife or Christian Kühn: [office@qu.uni-hamburg.de](mailto:office@qu.uni-hamburg.de).



Universität Hamburg has been certified,  
audit familiengerechte hochschule



physicsworld

A WORLD OF NEW BEGINNINGS

News and commentary for the global scientific community

INSPIRATION  
COMMUNICATION  
VISION  
OPINION  
RESEARCH  
INNOVATION  
BREAKTHROUGHS  
TRUST  
IMPACT  
KNOWLEDGE  
INSIGHT  
CONTEXT  
ANALYSIS  
LEARNING  
ENGAGE  
REASON  
INTELLECT  
THEORY



中国科学院高能物理研究所  
Institute of High Energy Physics  
Chinese Academy of Sciences

# IHEP RECRUITMENT OF OVERSEAS HIGH-LEVEL TALENTS

## INSTITUTE OF HIGH ENERGY PHYSICS, CHINESE ACADEMY OF SCIENCES



The Institute of High Energy Physics (IHEP) of the Chinese Academy of Sciences (CAS) invites applications for permanent staff positions at all levels. IHEP is a comprehensive research laboratory for particle and astroparticle physics, accelerator physics and technology, radiation technologies and applications, as well as for nuclear analytical techniques and interdisciplinary research.

For More Information: <http://english.ihep.cas.cn/>

#### Recruitment Objectives:

Based on the needs of the research areas and the disciplines development of IHEP, we are now publicly recruiting overseas outstanding talents and scholars of relevant disciplines who possess research abilities and innovation awareness.

#### Programs:

- 1 National "Thousand Talents Program" (full time & part time programs) for established scientists
- 2 National "Thousand Young Talents Program" for outstanding junior scientists
- 3 Pioneer "Hundred Talents Program" of CAS for outstanding junior scientists, excellent junior detector or accelerator experts
- 4 "Outstanding Talents Program" of IHEP for scientific research or technical talents

#### Research Areas:

Experimental Particle and Nuclear Physics, Theoretical Physics, Astronomy and Astrophysics, Nuclear Technology, Accelerators, Neutron physics, Condensed matter physics, Chemistry, Biochemistry and Molecular Biology, Biophysics, Computing, Multidisciplinary Research.

#### Contact:

Office of Human Resources, Institute of High Energy Physics, Chinese Academy of Sciences

E-mail: [lianggj@ihep.ac.cn](mailto:lianggj@ihep.ac.cn) Tel: (86)010-88233157 Fax: (86)010-88233102

Address: No. 19 (B), Yuquan Road, Shijingshan District, Beijing (Postcode: 100049)

Applications should include a CV, an outline of academic accomplishments, description of current research and plan for future research, 3 – 5 published papers representative of your work, and a record of citations for your work. You should arrange for 3 letters of reference from experts in your field to be sent by post or email (established scientists are not requested).

For detailed information, please visit <http://english.ihep.cas.cn/doc/2649.html>



# Semiconductor detectors for high energy physics... ...going beyond the discovery of the Higgs boson

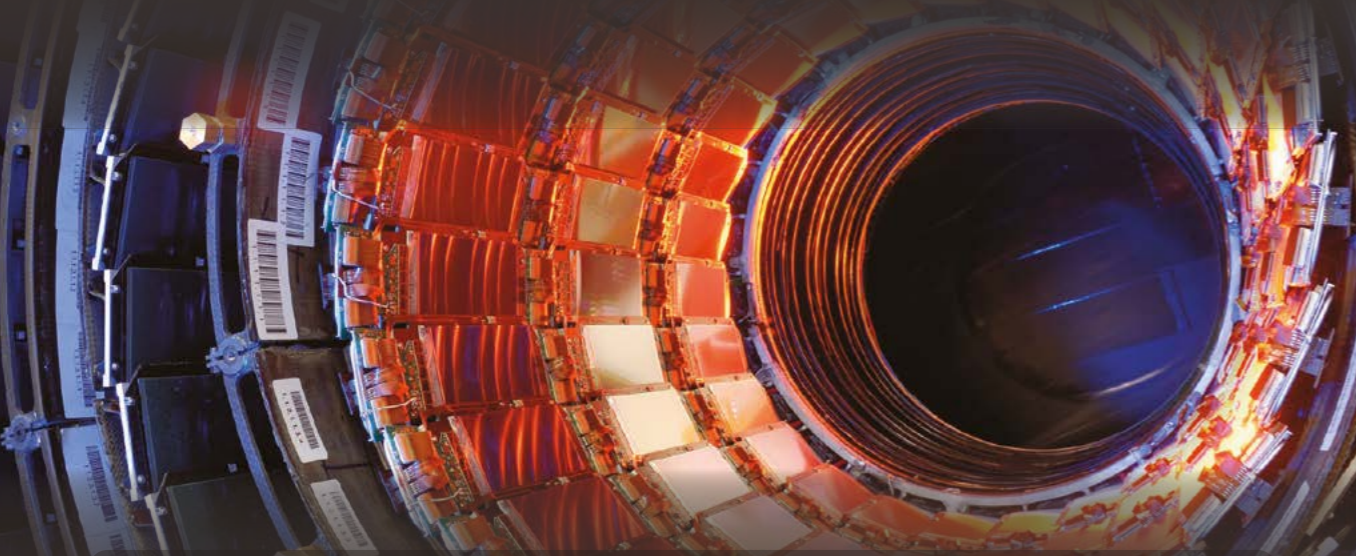

Hamamatsu Photonics continue their journey with CERN in the following experiments

8-inch PAD:  
CMS HGCAL

SiPM/MPPC:  
CMS HCAL, CMS BTL,  
CMS CEH,  
LHCb SciFi tracker

Pixel detectors:  
CMS tracker,  
LHCb tracker

Silicon Strip Detectors:  
CMS tracker,  
ATLAS tracker

More than 35 years ago, after the success using our photomultiplier tubes in their research, Hamamatsu Photonics started a journey together with the researchers at CERN to develop customised Si detectors to enable them to push the boundaries of their high energy physics experiments.

We are proud to continue that journey with the development of the next generation of detectors.



**HAMAMATSU**  
PHOTON IS OUR BUSINESS

www.hamamatsu.com

Image courtesy of CERN

## PEOPLE OBITUARIES

MICHAEL ATIYAH 1929–2019

### A giant of mathematics

The eminent mathematician Michael Atiyah died in Edinburgh on 11 January, aged 89. He was one of the giants of mathematics whose work influenced an enormous range of subjects, including theoretical high-energy physics.

Atiyah's most notable achievement, with Isadore Singer, is the "index theorem", which occupied him for more than 20 years and generated results in topology, geometry and number theory using the analysis of elliptic differential operators. In mid-life, he learned that theoretical physicists also made use of the theorem and this opened the door to an interaction between the two disciplines, which he pursued energetically until the end of his life. It led him not only to mathematical results on Yang-Mills equations, but also to encouraging the importation of concepts from quantum field theory into pure mathematics.

#### Early years

Born of a Lebanese father and a Scottish mother, his early years were spent in English schools in the Middle East. He then followed the natural course for a budding mathematician in that environment by attending the University of Cambridge, where he ended up writing his thesis under William Hodge and becoming a fellow at Trinity College. As a student he had little interest in physics, but went to hear Dirac lecture largely because of his fame. The opportunity then arose to spend a year at the Institute for Advanced Study in Princeton in the US, where he met his future collaborators and close friends Raoul Bott, Fritz Hirzebruch and Singer.

A visit by Singer to the University of Oxford (where Atiyah had recently moved) in 1962 began the actual work on the index theorem, where the Dirac operator would play a fundamental role. This ultimately led to Atiyah being awarded a Fields



Michael Atiyah's index theorem is a milestone of 20th century mathematics.

#### Michael was energetic in facilitating cooperation between mathematicians and physicists

Medal in 1966 and, with Singer, the Abel Prize in 2004. Over the years, proofs and refinements of the index theorem evolved. Although topology was at the forefront of the first approaches, in the early 1970s techniques using "heat kernels" became more analytic and closer to the calculations that theoretical physicists were performing, especially in the

context of anomalies in quantum field theory. In the 1980s, in a proof by Luis Álvarez-Gaumé (who subsequently became a member of the CERN theoretical physics unit for 30 years), Hirzebruch's polynomials in the Pontryagin classes – which form the topological expression for the index – emerged as a natural consequence of supersymmetry.

Singer visited Oxford again in 1977, this time bringing mathematical questions concerning Yang-Mills theory. Using quite sophisticated algebraic geometry and the novel work of Roger Penrose, this yielded a precise answer to physicists' questions about instantons, specifically the so-called ADHM (Atiyah, Drinfeld, Hitchin, Manin) construction. That mathematicians and physicists had common ground in a completely new context made a huge impression on Michael, and he was ener-

getic in facilitating this cooperation thereafter. He frequently engaged in correspondence and discussions with Edward Witten, out of which emerged the current fashion in mathematics of topological quantum field theories – beginning with a formalism that described new invariants of knots. Despite the quantum language of this domain, Michael's mathematical work with a physical interface was more concerned with classical solutions, and the soliton-like behaviour of monopoles and skyrmions.

#### Founding father

During his life he took on many administrative tasks, including the presidency of the Royal Society and mastership of Trinity College. He was also the founding director of the Isaac Newton Institute for Mathematical Sciences in Cambridge.

With his naturally effervescent personality he possessed, in Singer's words, "speed, depth, power and energy". Collaborations were all-important, bouncing ideas around with both mathematicians and physicists. Beauty in mathematics was also a feature he took seriously, as was a respect for the mathematicians and physicists of the past. He even campaigned successfully for a statue of James Maxwell to be erected in Edinburgh, his home city, in later years.

As for the index theorem itself, it is notable that one of the more subtle versions – the "mod 2 index" – played an important role in Kane and Mele's theoretical prediction of topological insulators. As they wrote in their 2005 paper: "it distinguishes the quantum spin-Hall phase from the simple insulator." A fitting tribute to an outstanding pure mathematician, whose intuition and technical power revealed so much in so many domains.

Nigel Hitchin University of Oxford.



HANS-JÜRIG GERBER 1929–2018

## A flair for the fundamental

Swiss physicist Hans-Jürg Gerber passed away on 28 August last year. Born in Langnau/Kanton Bern, he studied and did his PhD from 1949 to 1959 at ETH Zurich on “Scattering and polarization effects of 3.27 MeV neutrons on deuterons”. He then worked at the University of Illinois in the US, before joining CERN from 1962 to 1968. There, he carried out experiments at the 28 GeV Proton Synchrotron (PS). He studied high-energy neutrino interactions using a spark chamber, and performed measurements of lepton universality. He also tested time-reversal invariance in the charged decay mode of the  $\Lambda$  hyperon. He was also PS coordinator from 1965 to 1966.

In 1968, Gerber became head of the research department at the Swiss Institute for Nuclear Physics (SIN). He was elected by the Swiss Federal Council to become associate professor of experimental physics in 1970, and in 1977 promoted to full professor. Gerber initiated basic research at SIN and later at the Paul



Hans-Jürg Gerber carried out seminal work on T, CP and CPT invariance.

Scherer Institute (PSI) with his precision experiments on the decay of charged muons – experiments that continue to this day at PSI (see p45). His flair for the fundamental led to the most general determination of the leptonic four-fermion

interaction for the normal and inverse muon decay using experimental data, which brought him international recognition.

In the 1980s and 1990s, Hans-Jürg returned to CERN to help set up and operate experiment PS195 (CPLER) for studying CP violation using a tagged neutral-kaon beam. The concept of the experiment, which involved tagging the flavour of the neutral kaon at the point of production, was opposite to already operational kaon experiments based on K-short and K-long beams. As a skilled experimenter, he contributed significantly to the success of CPLER with unconventional ideas. For example, during a crisis when the liquid-scintillator started to develop air bubbles due to the heat from nearby electronics, he invented a system to remove the air dissolved in the liquid using ultrasound. CPLER's measurements on the violation of time-reversal invariance (T-invariance) and tests of quantum mechanics were the starting point for signifi-

cant theoretical work he undertook on T, CP and CPT invariance.

While he retired in the spring of 1997 after a long and extremely successful career, he still continued working on particle physics with various publications on the interpretation of the CPLER results regarding testing of quantum mechanics, T- and CPT-violation. He was also a contributor to the review of particle physics in the Particle Data Group.

Experiment, theory and teaching formed a unity for Hans-Jürg. This was particularly evident in his lectures, in which he enthusiastically conveyed the joy of physics to his students. We also remember dinners with Hans-Jürg after long working days setting up experiments, where we talked about all possible physics questions.

He is survived by his wife Hildegard, his three children and grandchildren.

**His friends and colleagues at CERN.**

BASTIAAN DE RAAD 1931–2018

## CERN accelerator pioneer

Bas de Raad arrived at CERN in July 1954 at the tender age of 22 – two months before the Organization was formally established. After graduating from the Technical University of Delft in the Netherlands, he joined the team working on the design of the Proton Synchrotron (PS), based at that time in the École de Physique in Geneva, with special responsibility for the PS main magnets, which are still operating reliably to this day. He moved on to work on magnets for the external beams of the PS.

After a sabbatical year in Stanford in 1963/1964, he returned to the accelerators division at CERN to work on the design of the optics for the Intersecting Storage Rings (ISR), the first hadron collider. Later, he became leader of the ISR beam transfer group with responsibility for the design of the two long transfer lines from the PS to ISR, as well as the injection and



Machine expert Bas de Raad, photographed at CERN in 1975.

beam-dumping systems.

On approval of the construction of the Super Proton Synchrotron (SPS) in 1970, Bas joined the core team of John Adams, where he led a much bigger group working on

the design and construction of all the transfer lines to and from the SPS (together with injection), and both resonant and fast-extraction systems and the beam dump. He was deputy division leader of the

SPS division from 1977 to 1981 and leader until the end of 1989.

Even with his heavy load as leader of one of the biggest divisions at CERN, he still managed to find time for technical work. In preparing the SPS to accelerate electrons and positrons for the Large Electron Positron collider, he realised the importance of shielding the SPS coils from synchrotron radiation and took on the job himself, spending many hours in the SPS tunnel fitting the shielding masks. From 1990 until his retirement in 1996 he was the leader of CERN's technical inspection and safety commission.

Bas was a great leader, training a new generation of machine builders during the construction of the ISR and the SPS with the meticulous attention to detail that he demanded of himself.

**His friends and colleagues.**



## VACUUM SOLUTIONS FROM A SINGLE SOURCE

Pfeiffer Vacuum is proud to have been a supplier of innovative and customized vacuum solutions to the particle accelerator community for more than 50 years. Our complete product portfolio for vacuum technology, our focus on competent and specialized advice supported by robust and reliable service, makes Pfeiffer Vacuum the partner of choice for the analytical and research communities worldwide.

- Pumps for vacuum generation down to UHV
- Vacuum measurement and analysis equipment
- Leak detectors and integrity test systems
- System technology and contamination management solutions
- Chambers and components

Are you looking for a perfect vacuum solution? Please contact us:  
**Pfeiffer Vacuum (Schweiz) AG** · T +41 44 444 22 55 · F +41 44 444 22 66  
 info@pfeiffer-vacuum.ch · www.pfeiffer-vacuum.com



# BACKGROUND

Notes and observations from the high-energy physics community

## Acronyms anonymous

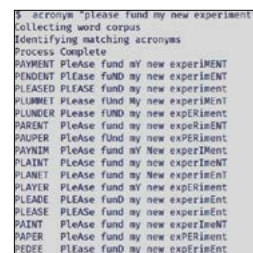

Acronyms are part of the joy and frustration of being a particle physicist, with no end of wordplay in sight – just look at the feat of the recently created ABRACADABRA (A Broadband/Resonant Approach to Cosmic Axion Detection with an Amplifying B-field Ring Apparatus) collaboration. Astronomers are similarly afflicted, says Ben Cook of the Center for Astrophysics | Harvard & Smithsonian, prompting him to offer help: ACRONYM is a command-line program to assist astronomers in identifying the best acronyms. In true astronomer fashion, writes Cook in a preprint published on 1 April (arXiv 1903.12180), the code returns all approximately English-language words that appear within an input string of text regardless of whether the letters occur at the beginning of the component words. It is available as an open-source Python package on GitHub, and particle physicists should take note: “With widespread use, ACRONYM should revolutionise the field of astronomy by freeing researchers from the burdensome task of brainstorming convoluted acronyms for their projects, adding back countless hours of productive work to the research cycle,” concludes Cook.

Smithsonian, prompting him to offer help: ACRONYM is a command-line program to assist astronomers in identifying the best acronyms. In true astronomer fashion, writes Cook in a preprint published on 1 April (arXiv 1903.12180), the code returns all approximately English-language words that appear within an input string of text regardless of whether the letters occur at the beginning of the component words. It is available as an open-source Python package on GitHub, and particle physicists should take note: “With widespread use, ACRONYM should revolutionise the field of astronomy by freeing researchers from the burdensome task of brainstorming convoluted acronyms for their projects, adding back countless hours of productive work to the research cycle,” concludes Cook.

## Media corner

*“I am moved by the image of a species looking at an image of a curious empty hole looming in space.”*

**Janna Levin** reflecting on the first recorded image of a black hole (also see p10) in *Quanta Magazine*, 10 April.

*“His proposal was initially rejected by a royal commission, which pronounced that ‘so many centuries after the Creation, it is unlikely that anyone could find hitherto unknown lands of any value.’”*

**John Ellis** on Spain’s reaction to Christopher Columbus when he requested funding to explore a westerly route to Asia, pointing out that Columbus sailed west anyway and found “hitherto unknown” lands that have dominated the planet for the past century (*Nature* 567 311).

*“I never thought I’d have this kind of money, so it was all a bit hypothetical. It would be nice*

*to enable those who want to – refugees and people from minority and other under-represented groups – to stay on and do PhDs.”*

**Jocelyn Bell Burnell**, who won a Special Breakthrough Prize in 2018 for the discovery of pulsars, interviewed in the April issue of *Physics World* magazine about her new \$3m graduate-student fund.

*“I figured if I’d been five years older, I could not have become a mathematician, because the disapproval would be so strong.”*

**Karen Uhlenbeck**, the first woman to be awarded a prestigious Abel Prize (p61), interviewed in *The New Yorker* about gender politics in the field.

*“Left-brained music lovers will enjoy Roskilde’s Science Pavilion, where representatives from CERN and the Niels Bohr Institute will be on hand to educate people about particle physics.”*

*Forbes* magazine (27 March) trails the lineup at this year’s Roskilde Festival in Denmark, 29 June – 7 July.

## From the archive: May 1976

### Physics awards

Victor F Weisskopf has been awarded the Oersted Medal, the highest award of the American Association of Physics Teachers. It is given for outstanding contributions in the teaching of physics and can rarely have had a more deserving recipient than “Viki” Weisskopf. His general lectures on physics draw large audiences wherever he goes. For example, at MIT no lecture room could be found large enough to hold all who wished to attend his recent talks on “Modern Physics without Mathematics”. The photo shows him in discussion with vacation students at CERN after one of the lectures given during his regular summer visits.



Professor E C G Stueckelberg has been awarded the 1976 Max Planck Medal for his basic work on field theory. Ernst Stueckelberg is presently Honorary Professor at the University of Geneva and also works in the Theory Division at CERN.

• Compiled from text on p185 of *CERN Courier* May 1976.

### Compiler’s note

*With his palpable enthusiasm for new ideas and young people, Viki Weisskopf was the much cherished director-general of CERN from 1961 to 1965. Under his direction, the fledgling laboratory developed into one of the foremost institutions in the subject.*

*The relative lack of renown for the Stueckelberg mechanism in modern field theory may be due to the idiosyncratic style of eminent physicist Baron Ernst Carl Gerlach Stueckelberg von Breidenbach zu Breidenstein und Melsbach, a scion of Swiss aristocracy born in Basel in 1905. Older readers might recall his attendance at CERN seminars accompanied by his little dog.*

**>10<sup>15</sup>** Number of ways string theory’s six extra dimensions can be “compactified” to yield the (minimally supersymmetric) Standard Model, according to “A quadrillion Standard Models from F-theory” (arXiv 1903.00009).

## Wish you were here

On 14 March, during an afternoon visit to the Antiproton Decelerator, Pink Floyd frontman Roger Waters stopped for a photo (with his host, CERN’s Connie Potter) next to a poster-sized, antihydrogen-themed cover of the *Courier*. One can only assume the legendary lyricist, waiting for someone or something to show him the way, was struck by the spectral similarities to the cover art of *Dark Side of the Moon*.



# RE-EARTH-BASED HIGH TEMPERATURE SUPERCONDUCTORS

OUTSTANDING PERFORMANCE FOR DEMANDING APPLICATIONS

SUPERIOR IN-FIELD CRITICAL CURRENT

EXCELLENT MECHANICAL PROPERTIES

EXTREMELY UNIFORM CRITICAL CURRENT

MANUFACTURED USING OPTIMISED IBAD AND PLD PROCESSES

VOLUME PRODUCTION AVAILABLE NOW.

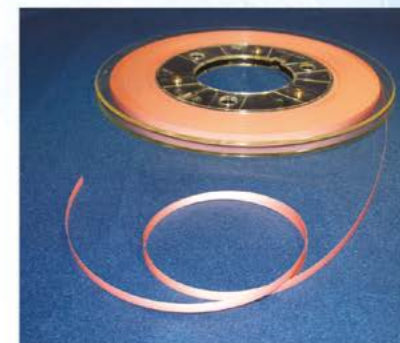

**CONTACT**  
Japan and other areas  
Phone: +81-43-484-3048  
Email: ask-sc@jp.fujikura.com

**CONTACT**  
Europe  
Phone: +44 208 240 2011  
Email: superconductors@fujikura.co.uk

Website: [www.fujikura.com/solutions/superconductingwire](http://www.fujikura.com/solutions/superconductingwire)



# One Company for All your High Voltage & Low Voltage Power Supply needs

CHECK THIS OUT!



CMS muon system HV power supplies

## Power supplies for every detector:

- |                                 |  |
|---------------------------------|--|
| Photomultipliers                | MicroMegas                                       |
| Photodiodes                     | Resistive Plate Chambers                         |
| Avalanche Photodiodes           | Gas Electron Multipliers                         |
| Silicon photomultipliers        | Germanium  |
| Silicon Strips, Drift and Pixel | <b>Hostile Area:</b>                             |
| Wire Chambers                   | Magnetic fields and Radiation Tolerant solutions |

**40**  
YEARS of INNOVATION  
1979-2019

CAEN celebrates 40 years of commitment and successful synergies with you

[www.caen.it](http://www.caen.it)  
Small details... Great differences

## High Voltage & Low Voltage Power Supplies Products

